



DESCRIPTION

The AM40T120B is available in TO-247 Package

VCES	IC	VCE	PD
1200V	40A	2.0V	357W

FEATURES

- Fast Switching
- Low V_{CE(sat)}: 2.0V
- Positive Temperature Coefficient
- Very Soft, Fast Recovery Anti-Parallel Diode
- I_{rrm}: 14.9A

APPLICATION

- UPS
- Welding Converters
- Converters With High Switching Frequency

PIN DESCRIPTION

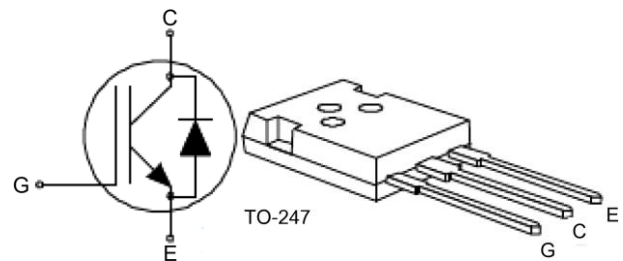

ORDERING INFORMATION

Package Type	Part Number	
TO-247 SPQ:30pcs/Tube	TL3F	AM40T120BTL3FU
		AM40T120BTL3FVU
Note	V: Halogen free Package U: Tube	
AiT provides all RoHS products		

Pin#	Symbol	Function
1	G	Gate
2	C	Collector
3	E	Emitter



ABSOLUTE MAXIMUM RATINGS

Parameter	Symbol	Value	Units
Collector-Emitter Voltage	V _{CES}	1200	V
Collector Current @ T _c = 25 °C	I _c	80	A
Collector Current @ T _c = 100 °C		40	A
Pulsed Collector Current ⁽¹⁾ @ T _c = 25 °C	I _{CM}	160	A
Diode Continuous Forward Current @ T _c = 25 °C	I _F	40	A
Diode Continuous Forward Current @ T _c = 100 °C		20	A
Diode Maximum Forward Current @ T _c = 25 °C	I _{FM}	160	A
Gate-Emitter Voltage	V _{GES}	±20	V
Power Dissipation @ T _c = 25 °C	P _D	357	W
Storage Temperature Range	T _{stg}	-55 to 150	°C
Junction Temperature	T _J	150	°C
Maximum Temperature for Soldering	T _L	260	°C
THERMAL CHARACTERISTICS			
Junction-to-Case (IGBT)	R _{θJC}	0.34	°C/W
Junction-to-Case (Diode)	R _{θJC}	0.8	°C/W
Junction-to-Ambient	R _{θJA}	40	°C/W

Stresses above may cause permanent damage to the device. These are stress ratings only and functional operation of the device at these or any other conditions beyond those indicated in the Electrical Characteristics are not implied. Exposure to absolute maximum rating conditions for extended periods may affect device reliability.

(1) Pulse width limited by maximum junction temperature



ELECTRICAL CHARACTERISTICS

T_A=25°C, unless otherwise specified.

Parameter	Symbol	Conditions	Min.	Typ.	Max.	Units
OFF CHARACTERISTICS						
Collector-Emitter Breakdown Voltage	V _{CES}	V _{GE} =0V, I _C =250μA	1200	-	-	V
Collector-Emitter Leakage Current	I _{CES}	V _{CE} = 1200V, V _{GE} = 0V	-	-	250	μA
Gate-Emitter Leakage Current	I _{GES(F)}	V _{GE} = +20V	-	-	600	nA
Gate-Emitter Reverse Leakage	I _{GES(R)}	V _{GE} = -20V	-	-	-600	nA
ON CHARACTERISTICS						
Collector-Emitter Saturation Voltage	V _{CE(sat)}	V _{GE} = 15V, I _C =40A	-	2.0	2.4	V
Gate Threshold Voltage	V _{GE(TH)}	V _{CE} = V _{GE} , I _C = 1mA	5.5	5.8	6.5	V
Pulse width tp≤300μs, δ≤2%						
DYNAMIC CHARACTERISTICS						
Input Capacitance	C _{iss}	V _{GE} = 0V	-	3633	-	pF
Output Capacitance	C _{oss}	V _{CE} = 25V	-	150	-	
Reverse Transfer Capacitance	C _{rss}	f = 1.0MHz	-	90	-	
Total Gate Charge	Q _g	I _C = 40A V _{CE} = 960V V _{GE} = 15V	-	270	-	nC
SWITCHING CHARACTERISTICS						
Turn-on Delay Time	t _{d(ON)}	I _C =40A	-	48	-	ns
Rise Time	t _r	V _{CE} = 600V	-	90	-	
Turn-Off Delay Time	t _{d(OFF)}	V _{GE} = 15V	-	275	-	
Fall Time	t _f	R _G =10Ω	-	55	-	
Turn-On Switching Loss	E _{on}	Inductive Load	-	4.694	-	mJ
Turn-Off Switching Loss	E _{off}		-	1.627	-	
Total Switching Loss	E _{ts}		-	6.321	-	
DIODE CHARACTERISTICS						
Diode Forward Voltage	V _F	I _F =40A	-	2	2.5	V
Reverse Recovery Time	T _{rr}	I _F =40A, di/dt=200A/us	-	73	-	nS
Reverse Recovery Charge	Q _{rr}		-	654	-	nC
Reverse Recovery Current	I _{rrm}		-	14.9	-	A



TYPICAL PERFORMANCE CHARACTERISTICS

Fig.1 Forward Bias Safe Operating Area

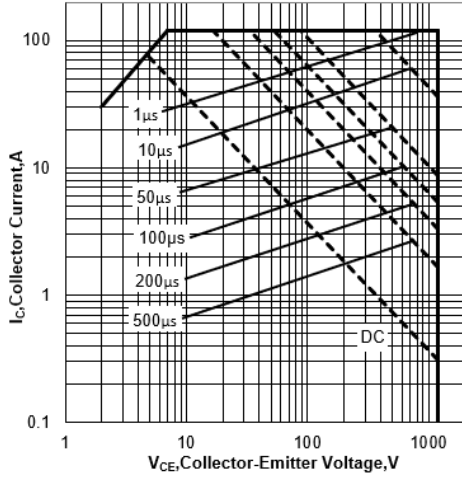

Fig.2 Power Dissipation vs Case Temperature

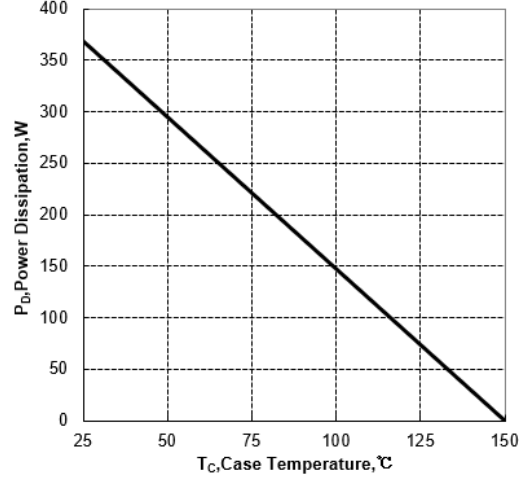

Fig.3 Collector Current vs Case Temperature

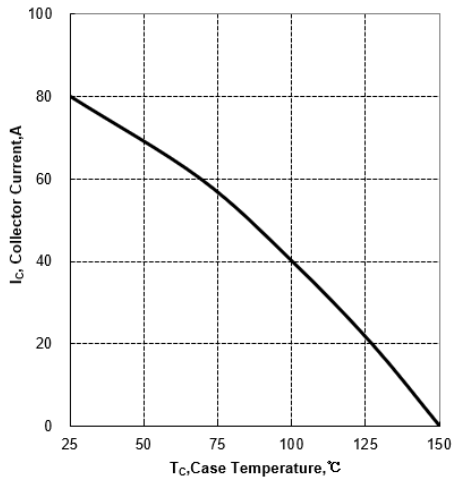

Fig.4 Typical Transfer Characteristics

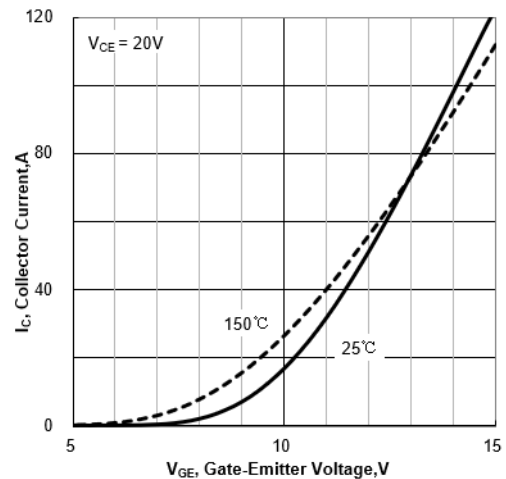

Fig.5 Typical Output Characteristics (T_C=25°C)

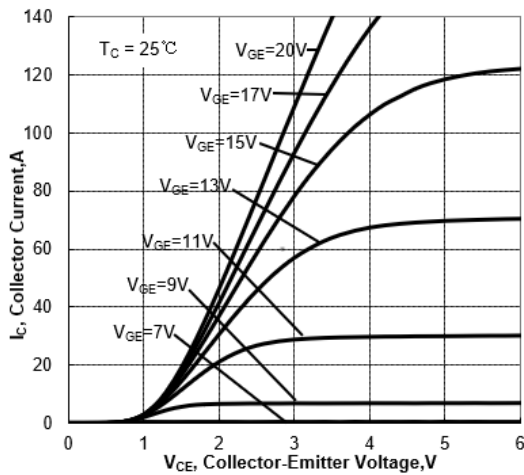

Fig.6 Typical Output Characteristics (T_C=150°C)

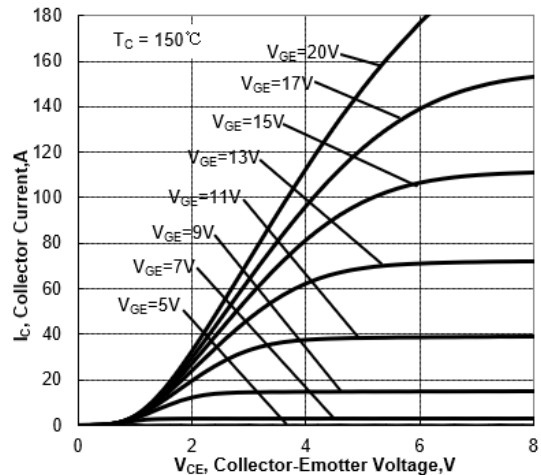



Fig.7 Typical Collector-Emitter Saturation Voltage vs Junction Temperature

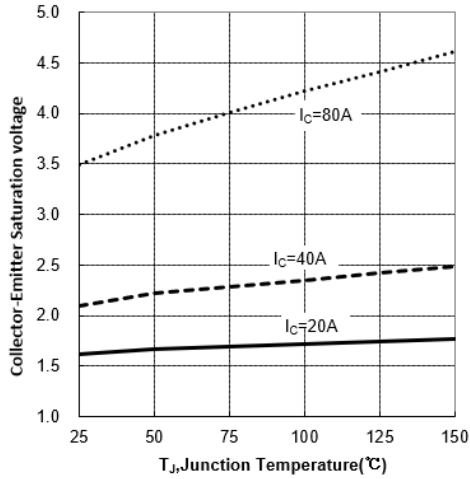

Fig.8 Typical Transfer Characteristics

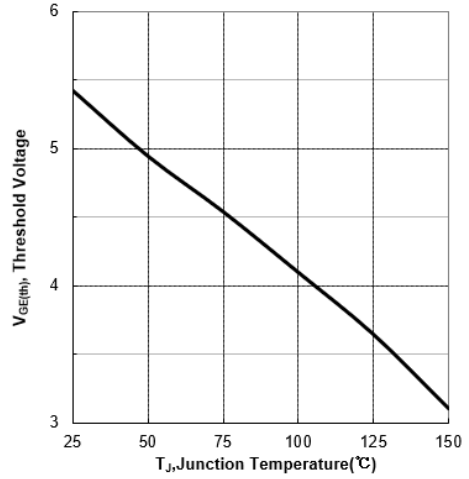

Fig.9 Typical Gate Charge

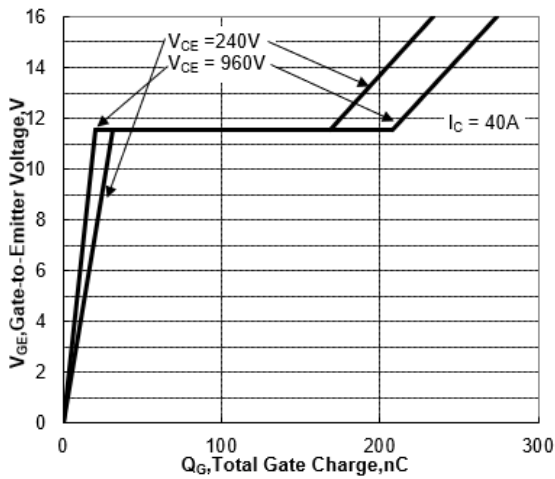

Fig.10 Typical Capacitance vs Collector-Emirrer Voltage

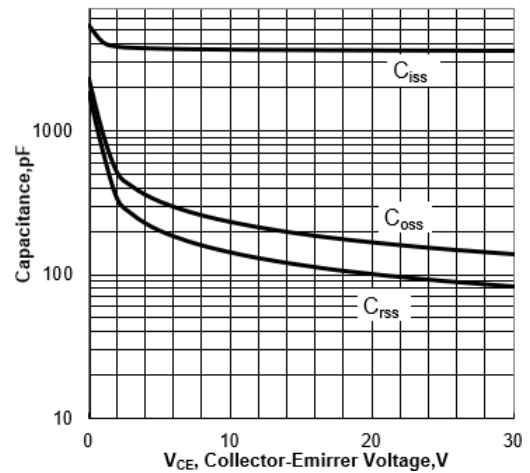

Fig.11 IGBT Transient Thermal Impedance vs Pulse Width

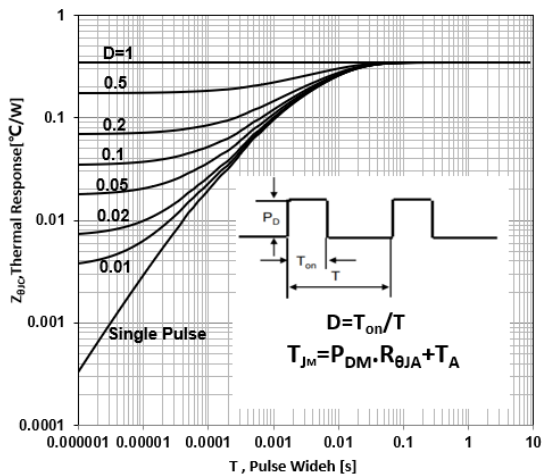

Fig.12 Typical Diode Forward Current vs Forward Voltage

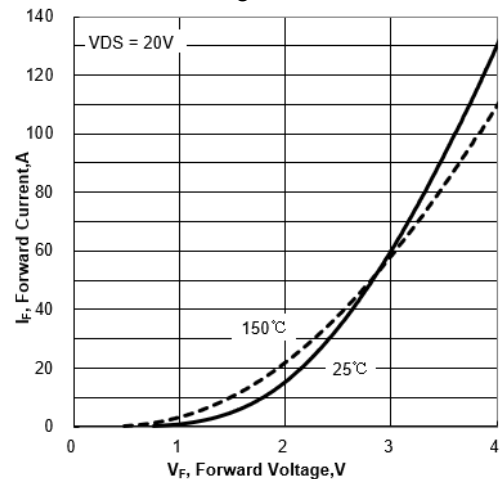



Fig.13 Inductive Switching Test Circuit

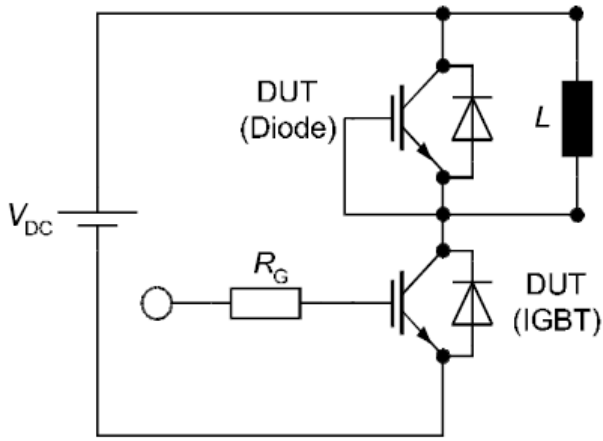

Fig.14 Inductive Switching Waveforms

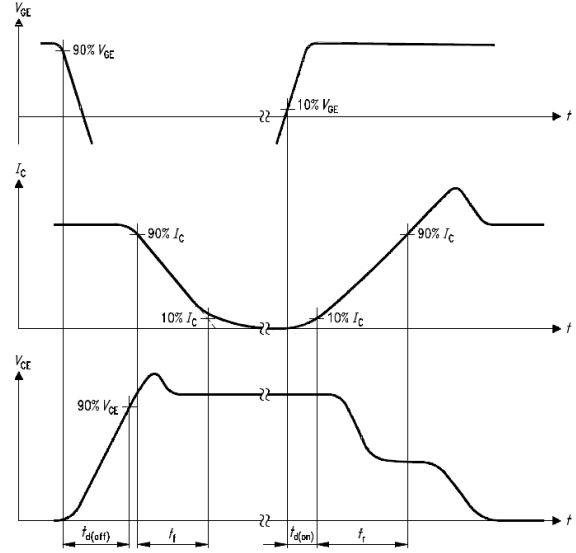

Fig.15 Inductive Switching Waveforms

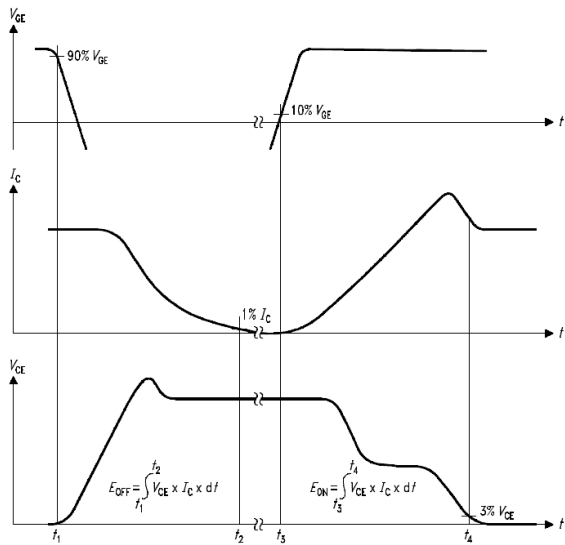
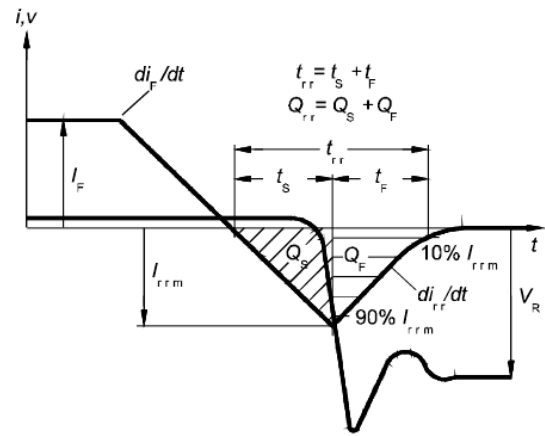

Fig.16. Inductive Switching Waveforms





PACKAGE INFORMATION

Dimension in TO-247 (Unit: mm)

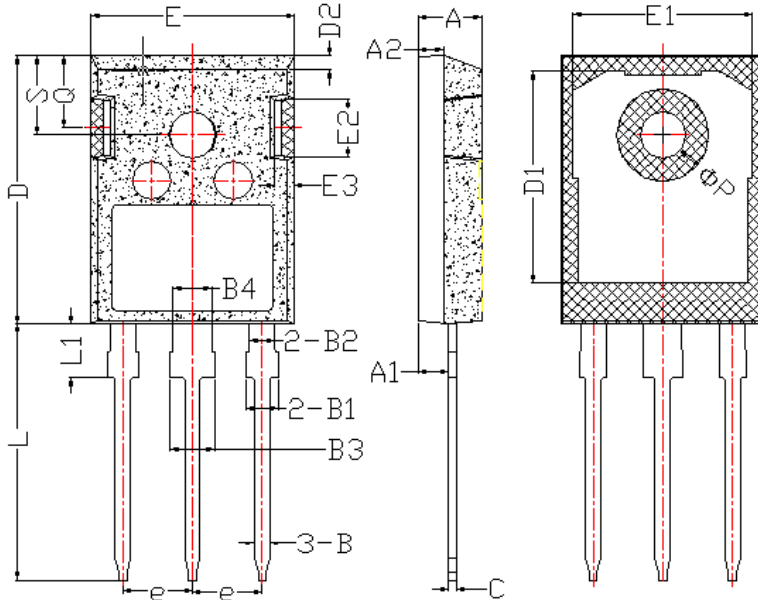

Symbol	Min.	Max.	Symbol	Min.	Max.
A	4.900	5.160	D2	1.050	1.350
A1	2.270	2.530	E	15.700	16.030
A2	1.850	2.110	E1	13.100	14.150
B	1.070	1.330	E2	3.680	5.100
B1	1.900	2.410	E3	1.680	2.600
B2	1.750	2.150	e	5.440	
B3	2.870	3.380	L	19.800	20.310
B4	2.870	3.130	L1	4.170	4.470
C	0.550	0.680	ΦP	3.500	3.700
D	20.820	21.100	Q	5.490	6.000
D1	16.250	17.650	S	6.040	6.300



IMPORTANT NOTICE

AiT Semiconductor Inc. (AiT) reserves the right to make changes to any its product, specifications, to discontinue any integrated circuit product or service without notice, and advises its customers to obtain the latest version of relevant information to verify, before placing orders, that the information being relied on is current.

AiT Semiconductor Inc. integrated circuit products are not designed, intended, authorized, or warranted to be suitable for use in life support applications, devices or systems or other critical applications. Use of AiT products in such applications is understood to be fully at the risk of the customer. As used herein may involve potential risks of death, personal injury, or server property, or environmental damage. In order to minimize risks associated with the customer's applications, the customer should provide adequate design and operating safeguards.

AiT Semiconductor Inc. assumes to no liability to customer product design or application support. AiT warrants the performance of its products of the specifications applicable at the time of sale.