



DESCRIPTION

The A6345A is a low dropout (LDO) voltage regulator that can deliver up to 300mA of current while consuming only 3µA of quiescent current (typical).

The input operating range is specified from 2.5V to 45V, making it an ideal choice for two to six or more primary cell battery-powered applications, 9V alkaline and one or two-cell Li-Ion-Power applications.

A6345A provides wide input voltage range and ensure the stability of fixed output voltage of 1.8V, 2.5, 3.0, 3.3V and 5.0V.

The A6345A is available in SOT-223 and SOP8 packages.

ORDERING INFORMATION

Package Type	Part Number	
SOT-223 SPQ: 1,000pcs/Reel	N	A6345ANR-XXZ
		A6345ANVR-XXZ
SOP8 SPQ: 4,000pcs/Reel	M8	A6345AM8R-XX
		A6345AM8VR-XX
Note	XX: Output Voltage 25=2.5V; 33=3.3V Z: Package Type see pin description V: Halogen free Package R: Tape & Reel	
AiT provides all RoHS products		

FEATURES

- Reduced Ground Current During Dropout
- Faster Startup Time
- 3.0µA Typical Quiescent Current
- Input Operating Voltage Range: 2.5V to 45V
- 300mA Output Current
- Low Dropout Voltage, 335mV Typical@100mA for 3.3Vout.
- ±2% Typical Output Voltage Tolerance, ±1% can be customized
- 1.8V, 2.5, 3.0, 3.3V, 5.0V Fixed Output Voltage
- Current Limit Protection
- Over Temperature Protection
- Available in SOT-223, and SOP8 packages

APPLICATION

- Battery-Powered Devices
- Battery-Powered Alarm Circuits
- Smoke Detectors
- CO₂ Detectors
- Smart Battery Packs
- Low Quiescent Current Voltage Reference
- BMS systems
- Motor control system/Industrial control system
- Power Meter/Instrument
- Solar-Powered Instrument
- White Goods
- Vehicle-mounted system
- Automotive Head Unit
- Security Equipment
- Communication Equipment

TYPICAL APPLICATION

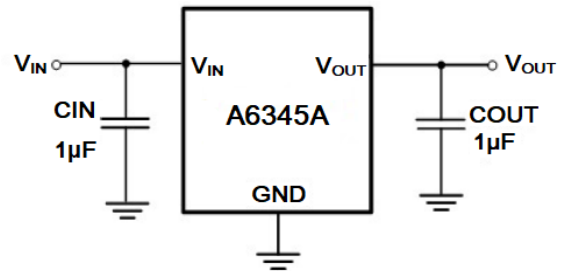



PIN DESCRIPTION

<p>A6345A-A SOT-223</p> <p>Top View</p>		<p>A6345A-B SOT-223</p> <p>Top View</p>		<p>A6345A SOP8</p> <p>Top View</p>	
Pin #			Symbol	Function	
SOT-223		SOP8			
A	B				
1	3	2	V _{IN}	Regulator Input. Up to 45V input voltage. At least 1μF supply bypass capacitor is recommended.	
2	1	5,6,7,8	GND	Ground	
3	2	3	V _{OUT}	Regulator Output. Recommended output capacitor range: 1μF to 10μF.	
-	-	1	EN	Enable pin. Drive this pin high to enable the device, Low to put the device into low current shutdown.	
-	-	4	NC	No connection	



ABSOLUTE MAXIMUM RATINGS

over operating free-air temperature range, unless otherwise noted^{NOTE1}

V_{IN} , Input Voltage		-0.3V ~ 50V
V_{EN} , Enable Input Voltage		-0.3V ~ V_{IN}
T_J , Junction Temperature		-40°C ~ 150°C
P_D , Continuous Power Dissipation ^{NOTE2}		Internally Limited
ESD Ratings		
$V_{(ESD)}$, Electrostatic Discharge	Human-body model (HBM)	±4000V
	Charge device model (CDM)	±1500V

Stress beyond above listed “Absolute Maximum Ratings” may lead permanent damage to the device. These are stress ratings only and operations of the device at these or any other conditions beyond those indicated in the operational sections of the specifications are not implied. Exposure to absolute maximum rating conditions for extended periods may affect device reliability.

RECOMMENDED OPERATING CONDITIONS

over operating free-air temperature range, unless otherwise noted^{NOTE1}

Parameter	Symbol	Min.	Max.	Unit
Input Supply Voltage	V_{IN}	2.5	45	V
Output Current	I_{OUT}	0	300	mA
Capacitor of V_{IN} pin	C_{IN}	1	10	uF
Capacitor of V_{OUT} Pin	C_{OUT}	1	10	uF
Equivalent series resistance	ESR	5	100	mΩ
Operating Temperature	T_A	-40	+85 ^{NOTE2}	°C

NOTE1: All voltages are with respect to the GND pin.

NOTE2: The chip’s operating temperature is determined by the junction temperature (T_J), the relationship between T_A and T_J , please refer to the application note as below.



ELECTRICAL CHARACTERISTICS

$V_{IN} = V_{OUT} + 2V$, $C_{IN} = C_{OUT} = 1\mu F$, $V_{OUT} = 3.3V$, typical values are at $T_A = +25^\circ C$, unless otherwise noted.

Parameter	Symbol	Conditions	Min.	Typ.	Max.	Unit	
Input Voltage	V_{IN}		2.5 NOTE3	-	45	V	
Output Voltage Accuracy		$I_{OUT} = 10mA$	-2.0	-	2.0	%	
Ground Pin Current	I_Q	No load	-	3.0	4.0	μA	
Shutdown Current	I_{Q-OFF}	$V_{EN} = 0V$	-	0.1	1.0	μA	
Max Output Current ^{NOTE4}			300	350	-	mA	
Dropout Voltage ^{NOTE5}	V_{DROP}	$I_{OUT} = 100mA$	$V_{OUT} = 1.8V$	-	450	550	mV
			$V_{OUT} = 2.5V$	-	385	485	
			$V_{OUT} = 3.0V$	-	350	450	
			$V_{OUT} = 3.3V$	-	335	435	
			$V_{OUT} = 5.0V$	-	300	400	
Line Regulation	$\frac{\Delta V_{OUT}}{\Delta V_{IN} \times V_{OUT}}$	$V_{IN} = V_{OUT} + 2V$ to 36V, $I_{OUT} = 1mA$	-	0.05	0.2	%/V	
Load Regulation	ΔV_{OUT}	$V_{IN} = V_{OUT} + 1V$, $I_{OUT} = 1mA$ to 50mA	-	5	20	mV	
Output Current Limit	I_{LMT}	$V_{IN} = V_{OUT} + 1V$	300	450	-	mA	
Short Current	I_{SHORT}	$V_{OUT} = 0$	-	100	-	mA	
Power Supply Rejection Ratio	PSRR	$V_{OUT} = 3.3V$, $I_{OUT} = 10mA$	$f = 217Hz$	-	72	-	dB
			$f = 1kHz$	-	77	-	
			$f = 10KHz$	-	60	-	
EN Input Threshold	V_{ENH}		1.2	-	-	V	
	V_{ENL}		-	-	0.4		
Output Voltage Temperature Coefficient ^{NOTE6}	$\frac{\Delta V_{OUT}}{\Delta T_A \times V_{OUT}}$	$I_{LOAD} = 1mA$ $T_A = -40^\circ C$ to $+85^\circ C$	-	100	-	ppm/ $^\circ C$	
Output Noise Voltage	e_n	$V_{IN} = V_{OUT} + 1V$, $I_{OUT} = 1mA$, $V_{OUT} = 3.0V$, $f = 10Hz \sim 100KHz$	-	100	-	μV_{RMS}	
Thermal Shutdown Temperature	T_{SHDN}		-	170	-	$^\circ C$	
Thermal Shutdown Hysteresis	T_{SDH}		-	20	-	$^\circ C$	

NOTE3: $V_{IN} \geq V_{OUT(NOMINAL)}$, whichever is greater.

NOTE4: Maximum output current is affected by the PCB layout, size of metal trace, the thermal conduction path between metal layers, ambient temperature and the other environment factors of system. Attention should be paid to the dropout voltage when $V_{IN} < V_{OUT} + V_{DROP}$.

NOTE5: The dropout voltage is defined as $V_{IN} - V_{OUT}$, when V_{OUT} is 100mV below the value of V_{OUT} for $V_{IN} = V_{OUT(NOMINAL)} + 2V$.

NOTE6: Output voltage temperature coefficient is defined as the worst-case voltage change divided by the total temperature range.



TYPICAL PERFORMANCE CHARACTERISTICS

$V_{IN} = V_{OUT} + 2V$, $C_{IN} = C_{OUT} = 1\mu F$, $V_{OUT} = 3.3V$, typical values are at $T_A = +25^\circ C$, unless otherwise noted.

1. Line Transient Response

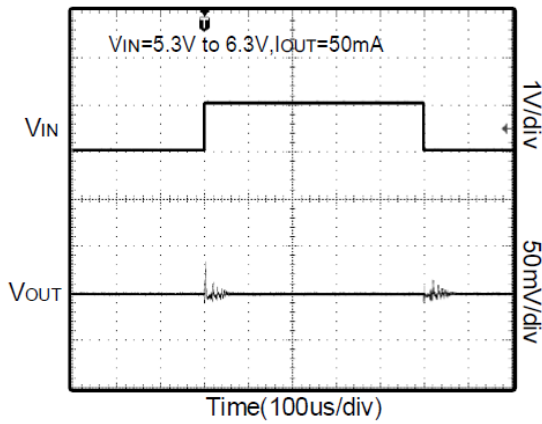

2. Power-Up/Power-Down Output Waveform

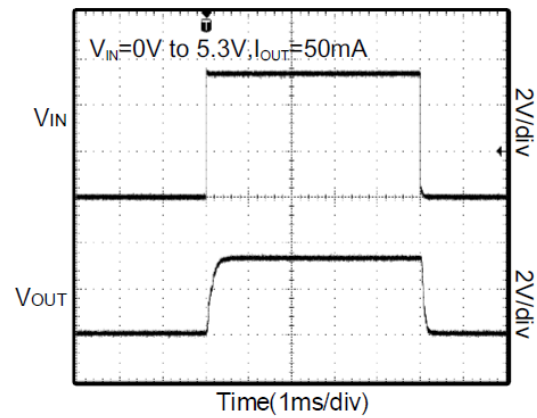

3. Load Transient Response

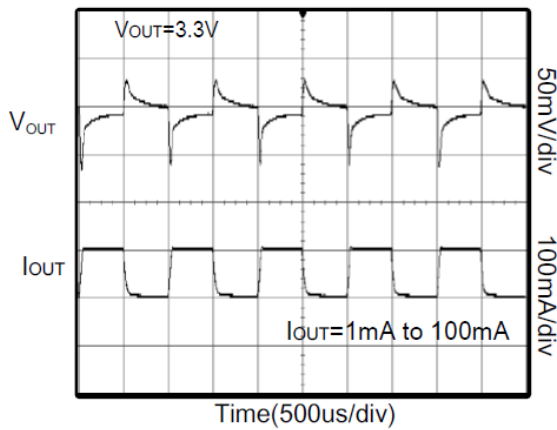

4. Load Transient Response

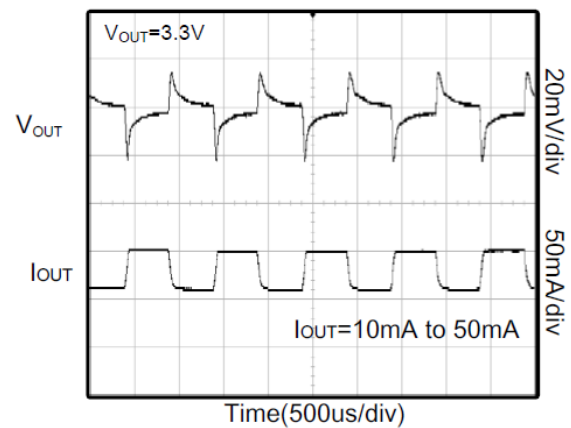

5. Line Regulation

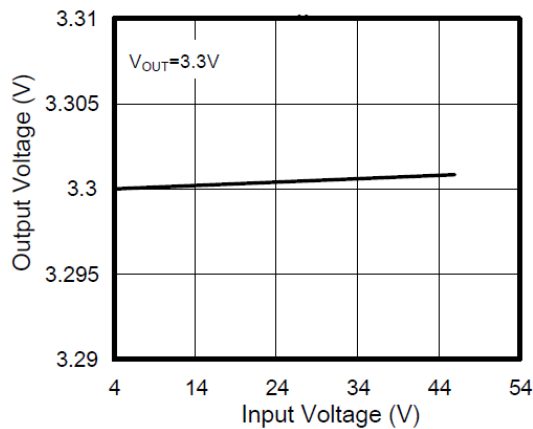

6. Load Regulation

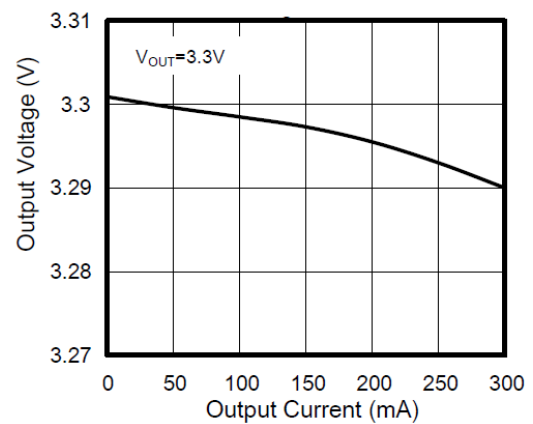



7. V_{OUT} vs. Temperature

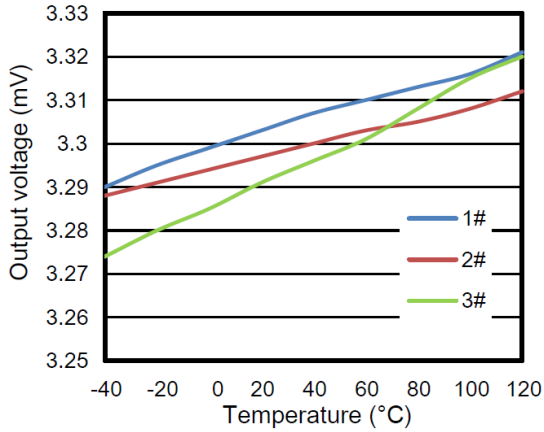

8. V_{DROP} vs. I_{OUT}

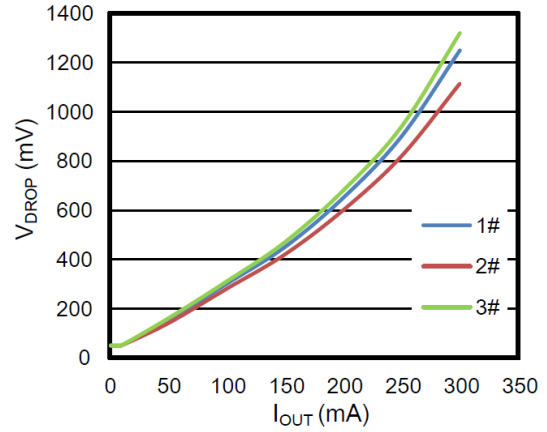

9. I_Q vs. Temperature

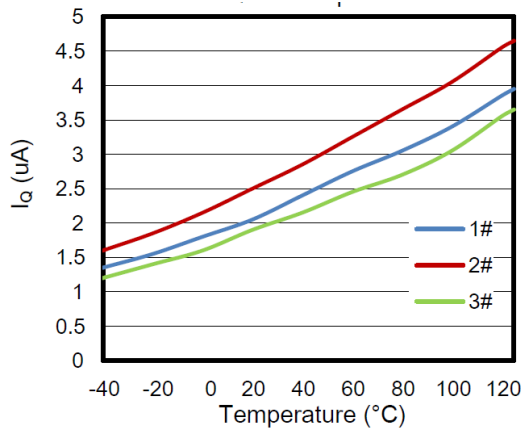

10. I_{OUT} vs. V_{DROP}

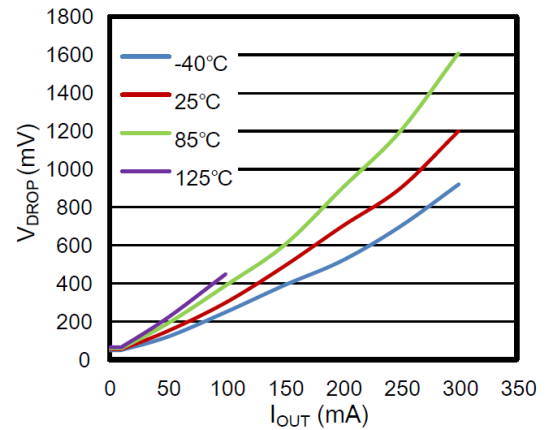

11. $V_{OUT-I_{OUT}}$ vs. Temperature

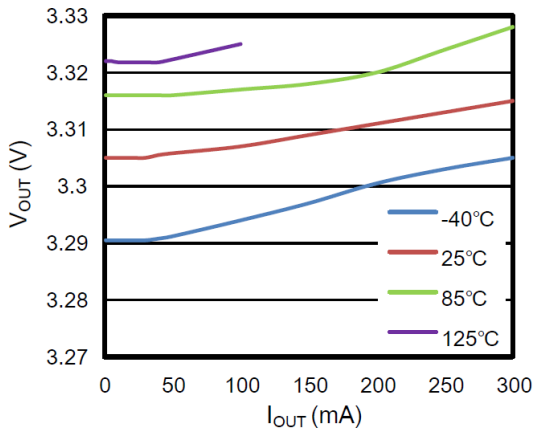

12. $V_{OUT-V_{IN}}$ vs. Temperature ($I_{OUT}=10mA$)

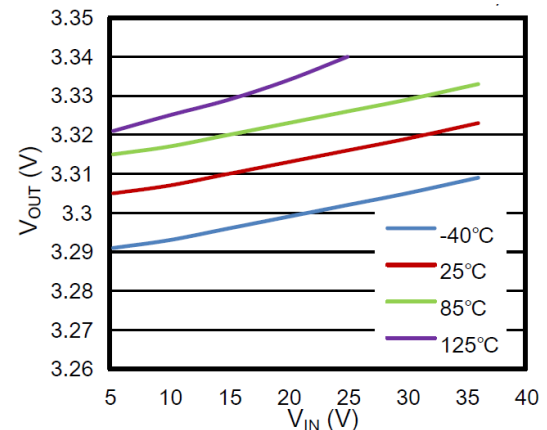



BLOCK DIAGRAM

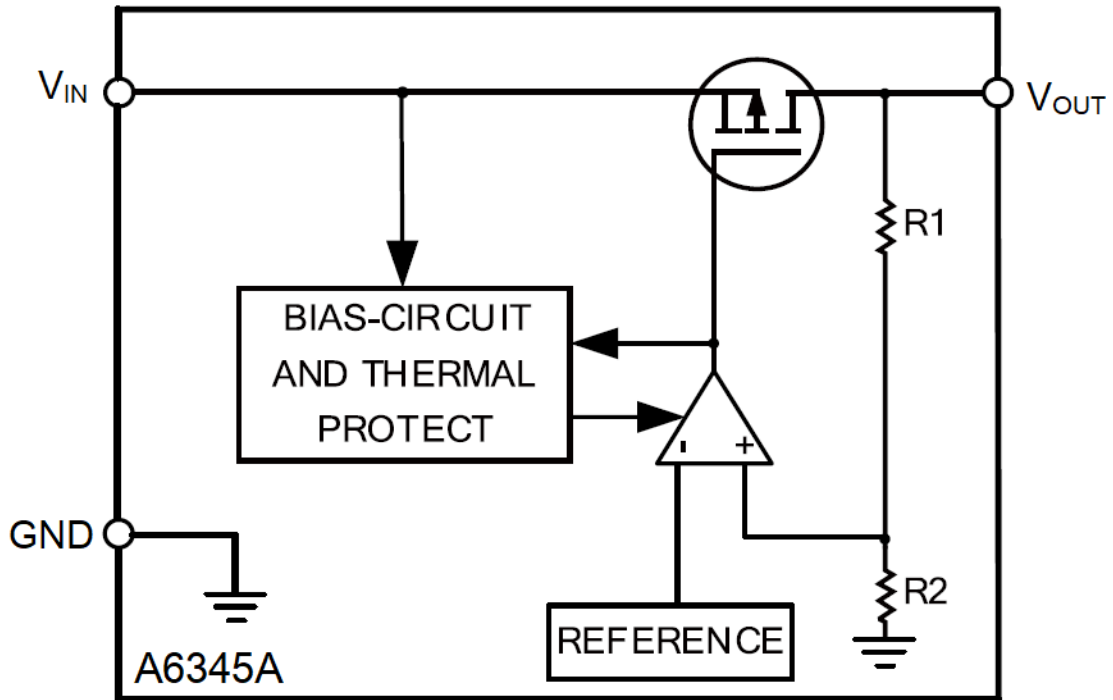



DETAILED INFORMATION

Overview

The A6345A low-dropout regulators (LDO) consumes only 3µA of quiescent current at light load and delivers excellent line and load transient performance. These characteristics, combined with low noise and good PSRR with low dropout voltage, make this device ideal for portable consumer applications.

Thermal Considerations

When the junction temperature is too high, the thermal protection circuitry sends a signal to the control logic that will shut down the IC. The IC will restart when the temperature has sufficiently cooled down. The maximum power dissipation is dependent on the thermal resistance of the case and the circuit board, the temperature difference between the die junction and the ambient air, and the rate of air flow. The GND pin must be connected to the ground plane for proper dissipation.

Applications Note:

1. The phase compensation circuit and ESR of the output capacitor are used inside the circuit to compensate, so a capacitor larger than 1.0µF must be connected to the ground.
2. It is recommended to use 1µF polar capacitors for input and output, and to keep the capacitors as close to the V_{IN} and V_{OUT} pins of LDO as possible.
3. Pay attention to the use conditions of input and output voltages and load currents to avoid the power consumption (P_D) inside the IC exceeding the maximum power consumption allowed by the package.

$$P_D = (V_{IN} - V_{OUT}) \times I_{OUT}$$

$$T_{PN} = P_D \times R_{\theta JA} + T$$

T_{PN} is junction temperature

T is ambient temperature.

4. When the input voltage V_{IN} is greater than 2.5V, if V_{IN} is also higher than the output set value plus the device dropout voltage, V_{OUT} is equal to the set value. Otherwise, V_{OUT} is equal to V_{IN} minus the dropout voltage. If V_{IN} lower than 2.5V, the V_{OUT} is:

$$V_{OUT} = V_{IN} - V_{Dropout}$$



PACKAGE INFORMATION

Dimension in SOT-223 (Unit: mm)

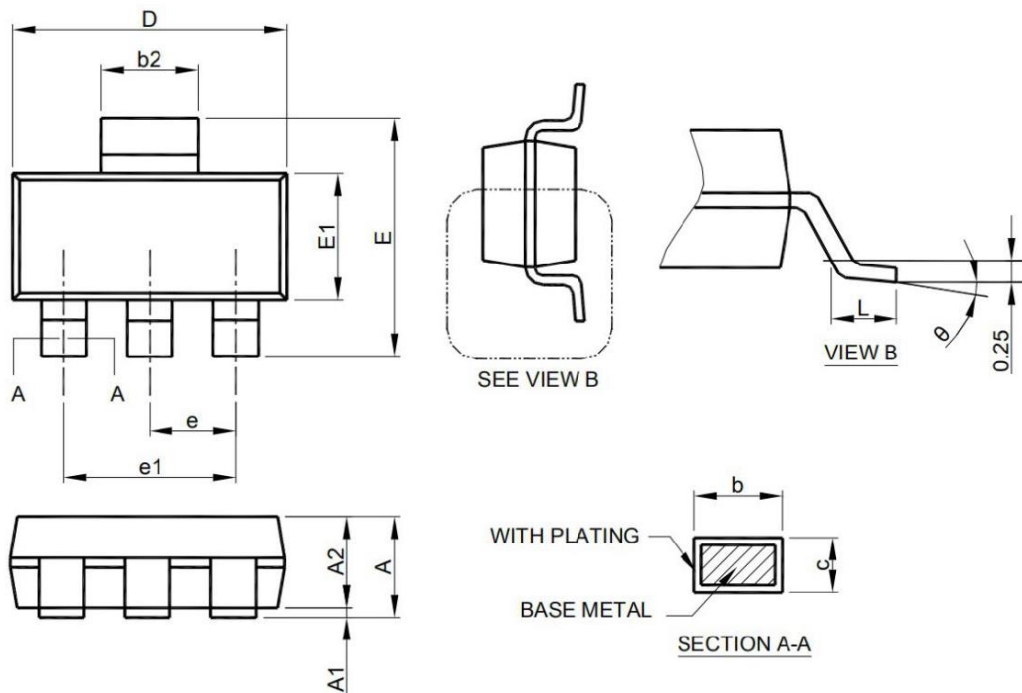

Symbol	Millimeters		Inches	
	Min	Max	Min	Max
A	-	1.80	-	0.071
A1	0.02	0.10	0.001	0.004
A2	1.55	1.65	0.061	0.065
b	0.66	0.84	0.026	0.033
b2	2.90	3.10	0.114	0.122
c	0.23	0.33	0.009	0.013
D	6.30	6.70	0.248	0.263
E	6.70	7.30	0.263	0.287
E1	3.30	3.70	0.130	0.145
e	2.30 BSC		0.090 BSC	
e1	4.60 BSC		0.181 BSC	
L	0.90	-	0.035	-



Dimension in SOP8 (Unit: mm)

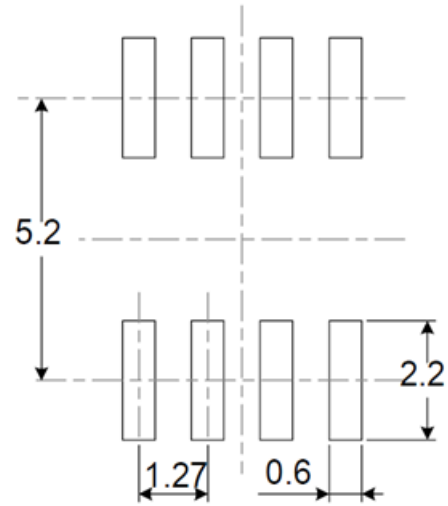
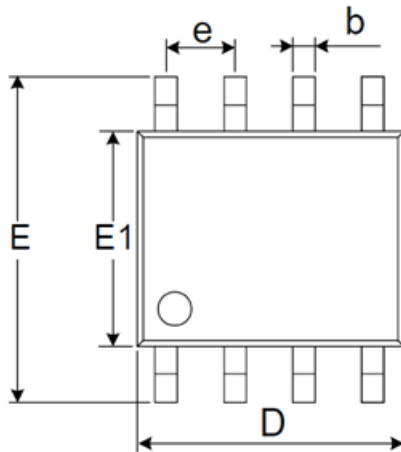

RECOMMENDED LAND PATTERN (Unit: mm)

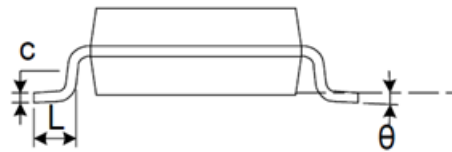
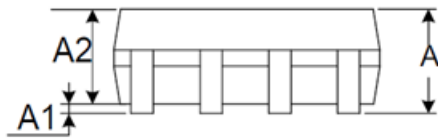

Symbol	Millimeters		Inches	
	Min	Max	Min	Max
A	1.350	1.750	0.053	0.069
A1	0.100	0.250	0.004	0.010
A2	1.350	1.550	0.053	0.061
b	0.330	0.510	0.013	0.020
c	0.170	0.250	0.007	0.010
D	4.800	5.000	0.189	0.197
e	1.270 BSC		0.050 BSC	
E	5.800	6.200	0.228	0.244
E1	3.800	4.000	0.150	0.157
L	0.400	1.270	0.016	0.050
θ	0°	8°	0°	8°



IMPORTANT NOTICE

AiT Semiconductor Inc. (AiT) reserves the right to make changes to any its product, specifications, to discontinue any integrated circuit product or service without notice, and advises its customers to obtain the latest version of relevant information to verify, before placing orders, that the information being relied on is current.

AiT Semiconductor Inc.'s integrated circuit products are not designed, intended, authorized, or warranted to be suitable for use in life support applications, devices or systems or other critical applications. Use of AiT products in such applications is understood to be fully at the risk of the customer. As used herein may involve potential risks of death, personal injury, or severe property, or environmental damage. In order to minimize risks associated with the customer's applications, the customer should provide adequate design and operating safeguards.

AiT Semiconductor Inc. assumes to no liability to customer product design or application support. AiT warrants the performance of its products of the specifications applicable at the time of sale.