



DESCRIPTION

The SM220A~SM2200A are available in SMA package.

ORDERING INFORMATION

Package Type	Part Number
SMA	SM220A
	SM240A
	SM260A
	SM280A
	SM2100A
	SM2120A
	SM2150A
	SM2200A
Note	5,000pcs/Reel
AiT provides all RoHS Compliant Products	

FEATURES

- Metal silicon junction, majority carrier conduction
- For surface mounted applications
- Low power loss, high efficiency
- High forward surge current capability
- For use in low voltage, high frequency inverters, free wheeling, and polarity protection applications
- Available in SMA package

MECHANICAL DATA

Case: SMA

Terminals: Solderable per MIL-STD-750,
Method 2026

Approx. Weight: 60mg / 0.0021oz

PIN DESCRIPTION





ABSOLUTE MAXIMUM RATINGS AND ELECTRICAL CHARACTERISTICS

Ratings at 25°C ambient temperature unless otherwise specified. Single phase, half wave, 60Hz resistive or inductive load, for capacitive load, derate by 20 %

Parameter	Symbol	SM 220A	SM 240A	SM 260A	SM 280A	SM 2100A	SM 2120A	SM 2150A	SM 2200A	Unit
Maximum Repetitive Peak Reverse Voltage	V_{RRM}	20	40	60	80	100	120	150	200	V
Maximum RMS Voltage	V_{RMS}	14	28	42	56	70	84	105	140	V
Maximum DC Blocking Voltage	V_{DC}	20	40	60	80	100	120	150	200	V
Maximum Average Forward Rectified Current	$I_{F(AV)}$	2.0								A
Peak Forward Surge Current, 8.3ms Single Half Sine-wave Superimposed on Rated Load (JEDEC method)	I_{FSM}	50				40				A
Max Instantaneous Forward Voltage at 2A	V_F	0.55	0.70		0.85		0.95		V	
Maximum DC Reverse Current at Rated DC Reverse Voltage	I_R	$T_A=25^\circ C$	0.5			0.3			mA	
		$T_A=100^\circ C$	5			3				
Typical Junction Capacitance ^{NOTE1}	C_J	220	80							pF
Typical thermal Resistance ^{NOTE2}	$R_{\theta JA}$	80								°C/W
Operating Junction Temperature Range	T_J	-55 to +125								°C
Storage Temperature Range	T_{stg}	-55 to +150								°C

NOTE1: Measured at 1MHz and applied reverse voltage of 4 V D.C.

NOTE2: P.C.B. mounted with 2.0" X 2.0" (5 X 5 cm) copper pad areas.



TYPICAL PERFORMANCE CHARACTERISTICS

Figure. 1 Forward Current Derating Curve

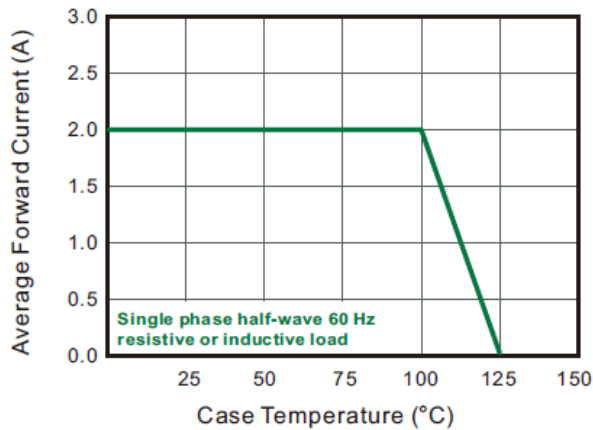

Figure. 2 Typical Reverse Characteristics

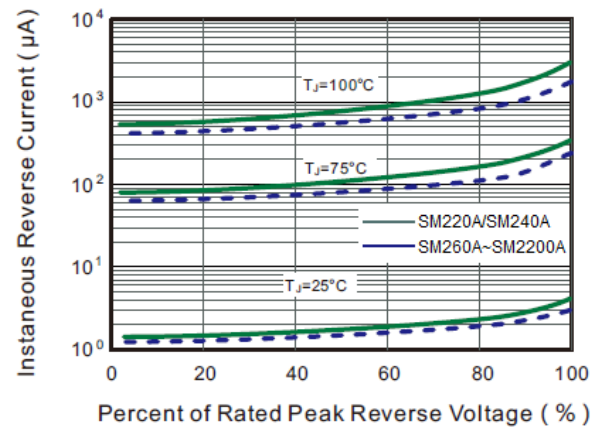

Figure. 3 Typical Forward Characteristic

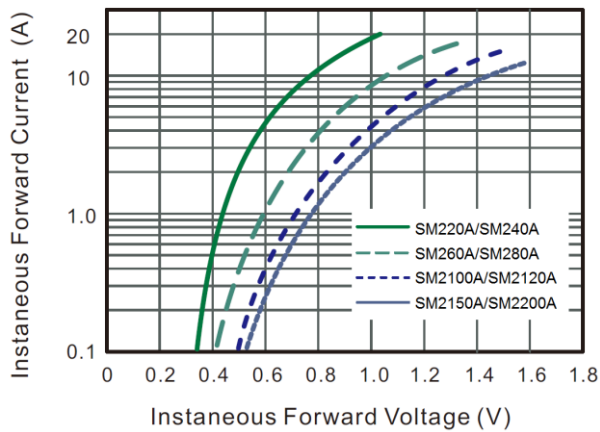

Figure. 4 Typical Junction Capacitance

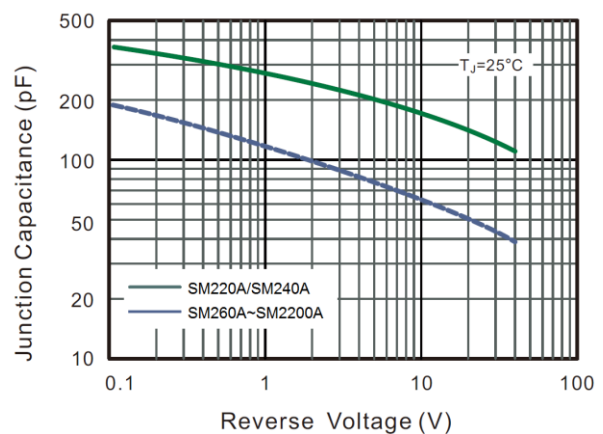

Figure. 5 Maximum Non-Repetitive Peak Forward Surge Current

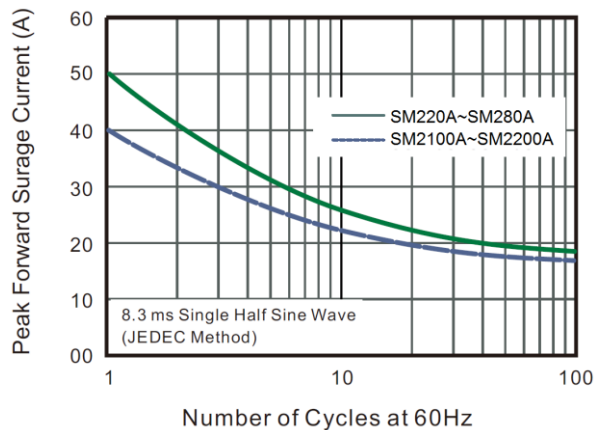
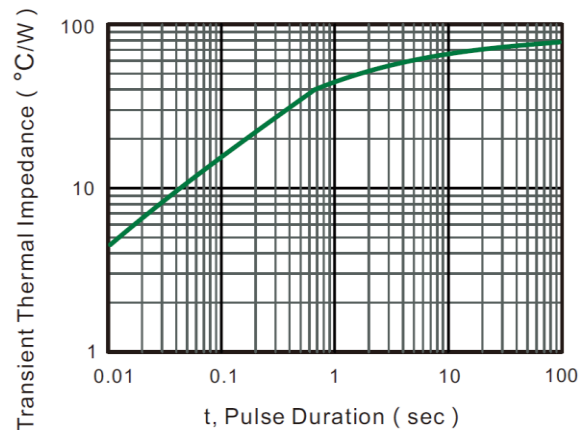

Figure. 6 Typical Transient Thermal Impedance





PACKAGE INFORMATION

Dimension in SMA Package (Unit: mm)

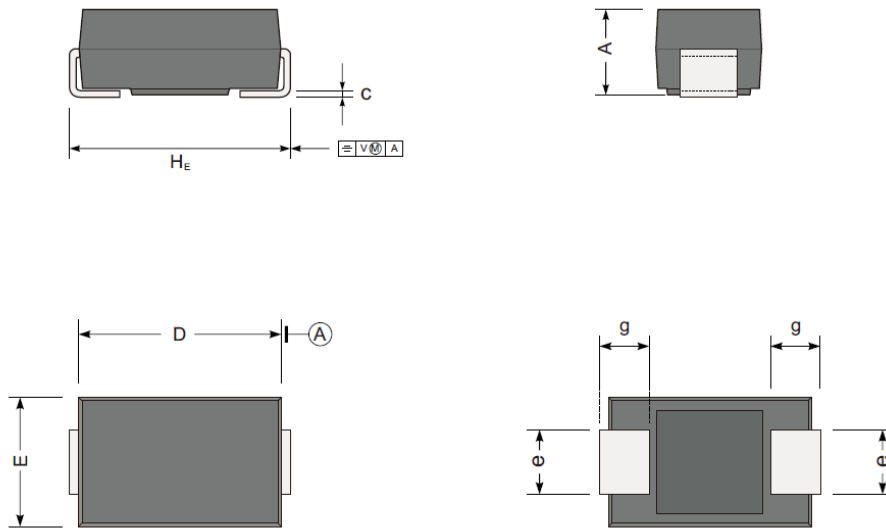

The recommended mounting pad size

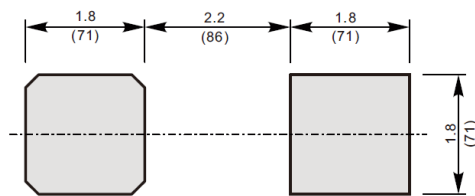

Unit : $\frac{\text{mm}}{\text{(mil)}}$

UNIT		A	D	E	H_E	c	e	g
mm	max	2.2	4.83	2.9	5.4	0.31	1.7	1.5
	min	1.9	4.32	2.3	4.7	0.12	1.2	0.9
mil	max	87	190	114	213	12	67	59
	min	75	170	91	185	5	47	35



IMPORTANT NOTICE

AiT Semiconductor Inc. (AiT) reserves the right to make changes to any its product, specifications, to discontinue any integrated circuit product or service without notice, and advises its customers to obtain the latest version of relevant information to verify, before placing orders, that the information being relied on is current.

AiT Semiconductor Inc.'s integrated circuit products are not designed, intended, authorized, or warranted to be suitable for use in life support applications, devices or systems or other critical applications. Use of AiT products in such applications is understood to be fully at the risk of the customer. As used herein may involve potential risks of death, personal injury, or severe property, or environmental damage. In order to minimize risks associated with the customer's applications, the customer should provide adequate design and operating safeguards.

AiT Semiconductor Inc. assumes to no liability to customer product design or application support. AiT warrants the performance of its products of the specifications applicable at the time of sale.