



## DESCRIPTION

This new series of digital transistors is designed to replace a single device and its external resistor bias network. The BRT (Bias Resistor Transistor) contains a single transistor with a monolithic bias network resistor. The BRT eliminates these individual components by integrating them into a single device. The use of a BRT can reduce both system cost and board space. The device is housed in the SOT-23 package which is designed for low power surface mount applications.

The MUN2211~MUN2241 are available in SOT-23 Package.

## ORDERING INFORMATION

Package Type	Part Number
SOT-23	MUN2211
	MUN2212
	MUN2213
	MUN2214
	MUN2215
	MUN2216
	MUN2230
	MUN2231
	MUN2232
	MUN2233
	MUN2234
	MUN2235
	MUN2238
	MUN2241
	Note
AiT provides all RoHS Compliant Products	

## FEATURES

- Simplifies Circuit Design
- Reduces Board Space and Component Count
- The SOT-23 package can be soldered using wave or reflow. The modified gull-winged leads absorb thermal stress during soldering eliminating the possibility of damage to the die.
- Available in SOT-23 Package

## PIN DESCRIPTION

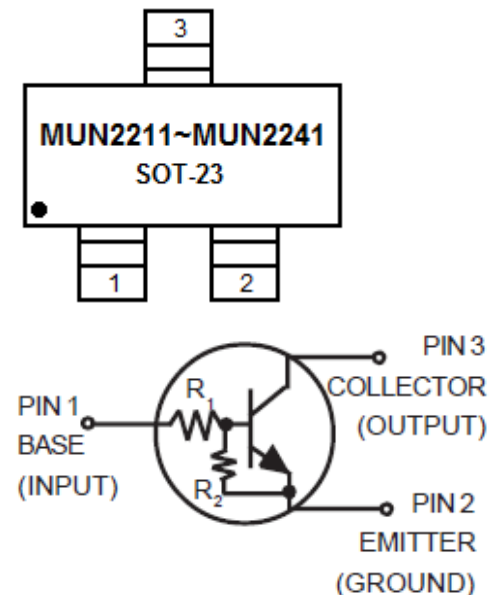



## ABSOLUTE MAXIMUM RATINGS

T<sub>A</sub> = 25°C unless otherwise noted.

V <sub>CBO</sub> , Collector-Base Voltage	50Vdc
V <sub>CEO</sub> , Collector-Emitter Voltage	50Vdc
I <sub>C</sub> , Collector Current	100mAdc
P <sub>D</sub> , Total Power Dissipation	
@ T <sub>A</sub> = 25°C <sup>NOTE1</sup>	246mW
Derate above 25°C	1.5°C/W

NOTE1: Device mounted on a FR-4 glass epoxy printed circuit board using the minimum recommended footprint.

## THERMAL CHARACTERISTICS

Parameter	Symbol	Value	Unit
Thermal Resistance-Junction-to-Ambient <sup>NOTE1</sup>	R <sub>θJA</sub>	508	°C/W
Operating and Storage Temperature Range	T <sub>J</sub> , T <sub>STG</sub>	-55 ~ +150	°C
Maximum Temperature for Soldering Purposes, Time in Solder Bath	T <sub>L</sub>	260	°C
		10	Sec

NOTE1: Device mounted on a FR-4 glass epoxy printed circuit board using the minimum recommended footprint.



## ELECTRICAL CHARACTERISTICS

T<sub>A</sub> = 25°C, unless otherwise noted.

Parameter	Symbol	Characteristic	Min	Typ	Max	Unit	
<b>OFF CHARACTERISTICS</b>							
Collector-Base Cutoff Current	I <sub>CBO</sub>	V <sub>CB</sub> = 50V, I <sub>E</sub> = 0	-	-	100	nAdc	
Collector-Emitter Cutoff Current	I <sub>CEO</sub>	V <sub>CE</sub> = 50V, I <sub>B</sub> = 0	-	-	500	nAdc	
Emitter-Base Cutoff Current	I <sub>EBO</sub>	V <sub>EB</sub> = 6.0V, I <sub>C</sub> = 0	-	-		MUN2211	0.5
						MUN2212	0.2
						MUN2213	0.1
						MUN2214	0.2
						MUN2215	0.9
						MUN2216	1.9
						MUN2230	4.3
						MUN2231	2.3
						MUN2232	1.5
						MUN2233	0.18
						MUN2234	0.13
						MUN2235	0.2
						MUN2238	4.0
MUN2241	0.1						
Collector-Base Breakdown Voltage	V <sub>(BR)CBO</sub>	I <sub>C</sub> = 10μA, I <sub>E</sub> = 0	50	-	-	Vdc	
Collector-Emitter Breakdown Voltage <sup>NOTE2</sup>	V <sub>(BR)CEO</sub>	I <sub>C</sub> = 2.0mA, I <sub>B</sub> = 0	50	-	-	Vdc	

NOTE2: Pulse Test: Pulse Width < 300μs, Duty Cycle < 2.0%.



T<sub>A</sub> = 25°C, unless otherwise noted.

Parameter	Symbol	Characteristic	Min	Typ	Max	Unit	
<b>ON CHARACTERISTICS</b> <small>NOTE2</small>							
DC Current Gain	h <sub>FE</sub>	V <sub>CE</sub> = 10V, I <sub>C</sub> = 5.0mA	MUN2211	35	60	-	-
			MUN2212	60	100		
			MUN2213	80	140		
			MUN2214	80	140		
			MUN2215	160	350		
			MUN2216	160	350		
			MUN2230	3.0	5.0		
			MUN2231	8.0	15		
			MUN2232	15	30		
			MUN2233	80	200		
			MUN2234	80	150		
			MUN2235	80	140		
			MUN2238	160	350		
			MUN2241	160	350		
Collector-Emitter Saturation Voltage	V <sub>CE(sat)</sub>	I <sub>C</sub> = 10mA, I <sub>B</sub> = 0.3mA	-	-	0.25	Vdc	
		I <sub>C</sub> = 10mA, I <sub>B</sub> = 5mA					MUN2230
							MUN2231
		I <sub>C</sub> = 10mA, I <sub>B</sub> = 1mA					MUN2215
							MUN2216
							MUN2232
							MUN2233
							MUN2234
							MUN2235
							MUN2238

NOTE2: Pulse Test: Pulse Width < 300μs, Duty Cycle < 2.0%.



T<sub>A</sub> = 25°C, unless otherwise noted.

Parameter	Symbol	Characteristic	Min	Typ	Max	Unit	
<b>ON CHARACTERISTICS</b> NOTE2							
Output Voltage (on)	V <sub>OL</sub>	V <sub>CC</sub> = 5.0V, V <sub>B</sub> = 2.5V, R <sub>L</sub> = 1.0kΩ	-	-	0.2	Vdc	
							MUN2211
							MUN2212
							MUN2214
							MUN2215
							MUN2216
							MUN2230
							MUN2231
							MUN2232
							MUN2233
							MUN2234
		MUN2235					
MUN2238							
		V <sub>CC</sub> = 5.0V, V <sub>B</sub> = 3.5V, R <sub>L</sub> = 1.0kΩ				MUN2213	
		V <sub>CC</sub> = 5.0V, V <sub>B</sub> = 5.0V, R <sub>L</sub> = 1.0kΩ				MUN2241	
Output Voltage (off)	V <sub>OH</sub>	V <sub>CC</sub> = 5.0V, V <sub>B</sub> = 0.5V, R <sub>L</sub> = 1.0kΩ	4.9	-	-	Vdc	
		V <sub>CC</sub> = 5.0V, V <sub>B</sub> = 0.050V, R <sub>L</sub> = 1.0kΩ					MUN2230
		V <sub>CC</sub> = 5.0V, V <sub>B</sub> = 0.25V, R <sub>L</sub> = 1.0kΩ					MUN2215
							MUN2216
							MUN2233
			MUN2238				

NOTE2: Pulse Test: Pulse Width < 300μs, Duty Cycle < 2.0%.



T<sub>A</sub> = 25°C unless otherwise noted.

Parameter	Symbol	Characteristic	Min	Typ	Max	Unit
<b>ON CHARACTERISTICS</b> NOTE2						
Input Resistor	R <sub>1</sub>	MUN2211	7.0	10	13	kΩ
		MUN2212	15.4	22	28.6	
		MUN2213	32.9	47	61.1	
		MUN2214	7.0	10	13	
		MUN2215	7.0	10	13	
		MUN2216	3.3	4.7	6.1	
		MUN2230	0.7	1.0	1.3	
		MUN2231	1.5	2.2	2.9	
		MUN2232	3.3	4.7	6.1	
		MUN2233	3.3	4.7	6.1	
		MUN2234	15.4	22	28.6	
		MUN2235	1.54	2.2	2.86	
		MUN2238	1.54	2.2	2.88	
		MUN2241	70	100	130	
Resistor Ratio	R <sub>1</sub> /R <sub>2</sub>	MUN2211	0.8	1.0	1.2	
		MUN2212				
		MUN2213				
		MUN2214	0.17	0.21	0.25	
		MUN2215	-	-	-	
		MUN2216				
		MUN2238				
		MUN2241	-	-	-	
		MUN2230	0.8	1.0	1.2	
		MUN2231				
		MUN2232				
		MUN2233	0.055	0.1	0.185	
		MUN2234	0.38	0.47	0.56	
		MUN2235	0.038	0.047	0.056	

NOTE3: Pulse Test: Pulse Width < 300μs, Duty Cycle < 2.0%.



## TYPICAL PERFORMANCE CHARACTERISTICS

1. Derating Curve

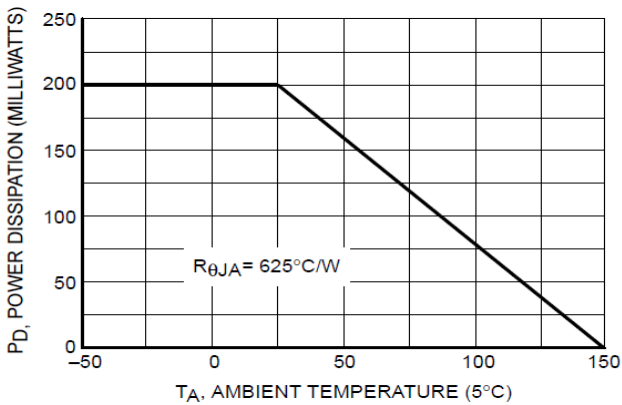

2.  $V_{CE(sat)}$  vs.  $I_C$

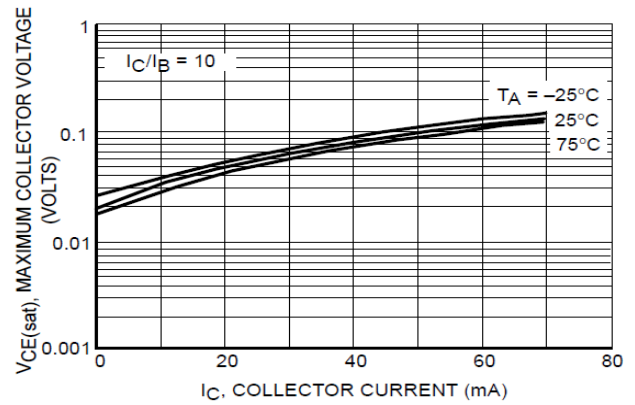

3. DC Current Gain

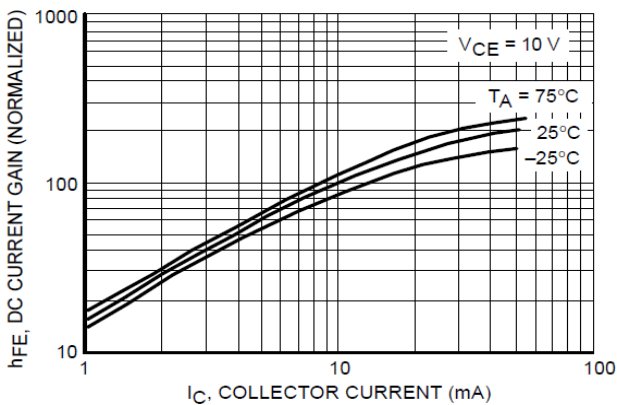

4. Output Capacitance

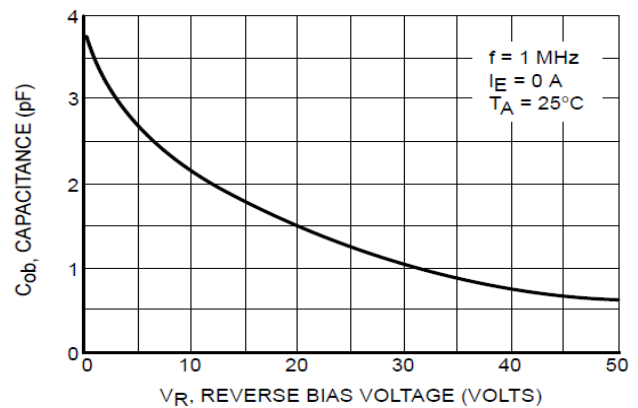

5. Output Current vs. Input Voltage

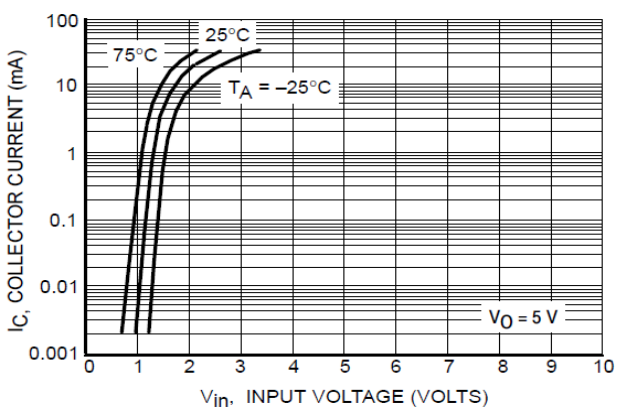

6. Input Voltage vs. Output Current

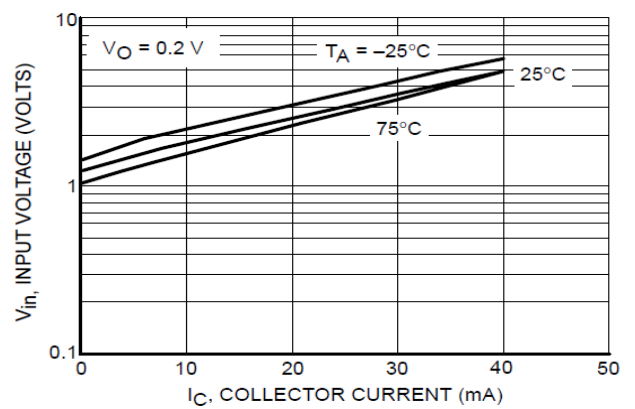



**MUN2212**

7.  $V_{CE(sat)}$  vs.  $I_C$

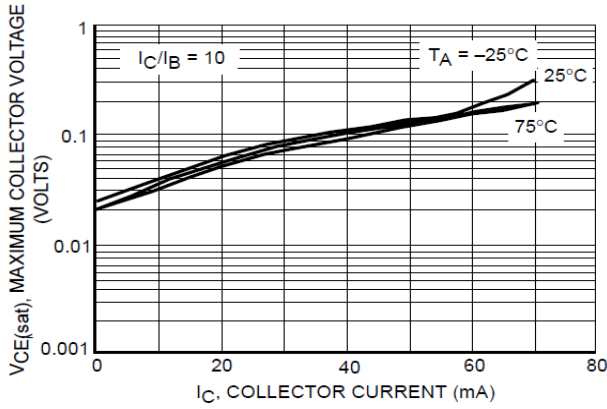

8. DC Current Gain

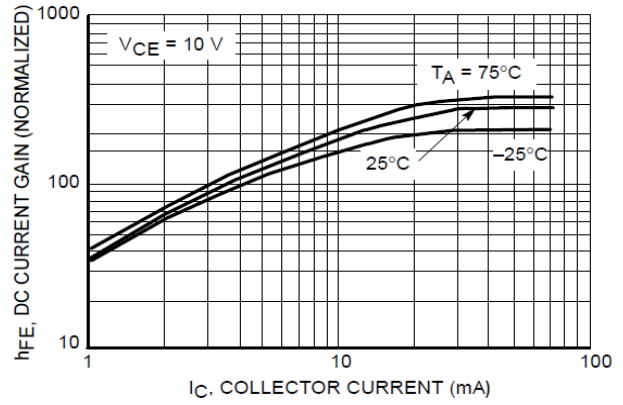

9. Output Capacitance

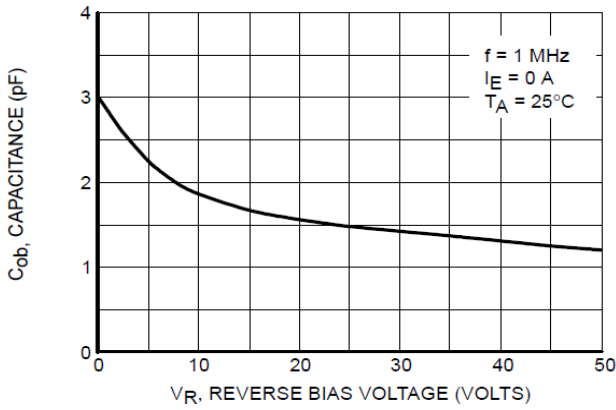

10. Output Current vs. Input Voltage

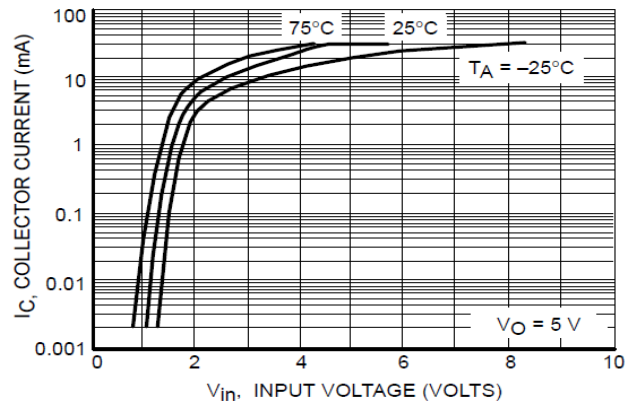

11. Input Voltage vs. Output Current

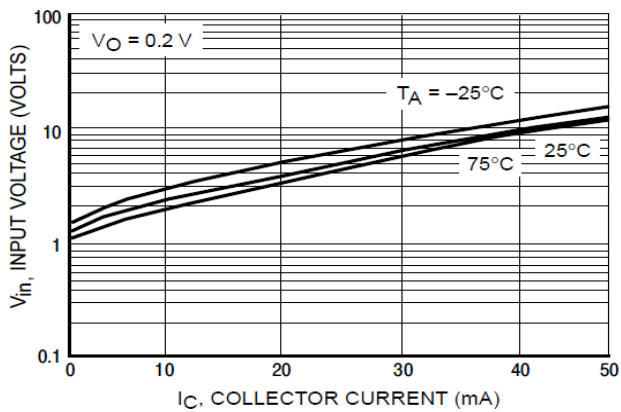





**MUN2213**

12.  $V_{CE(sat)}$  vs.  $I_C$

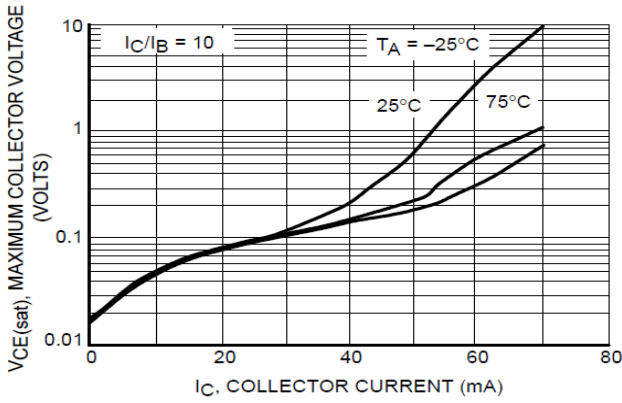

13. DC Current Gain

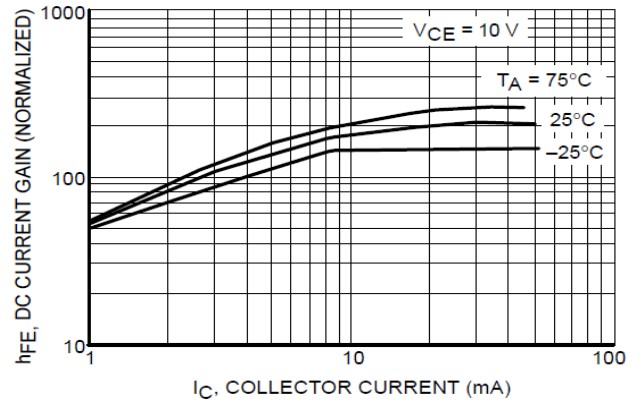

14. Output Capacitance

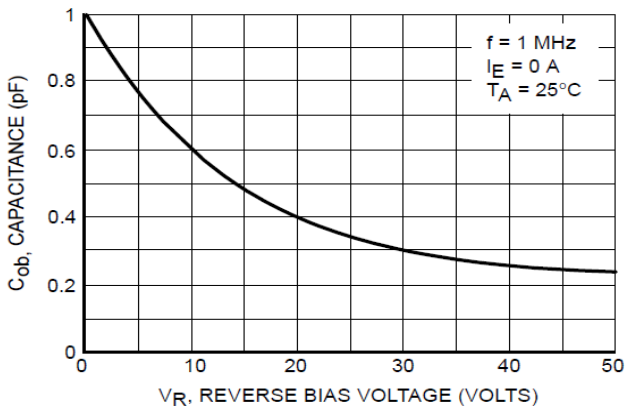

15. Output Current vs. Input Voltage

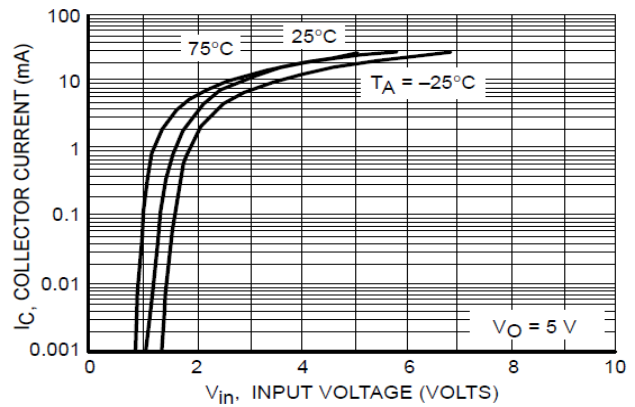

16. Input Voltage vs. Output Current

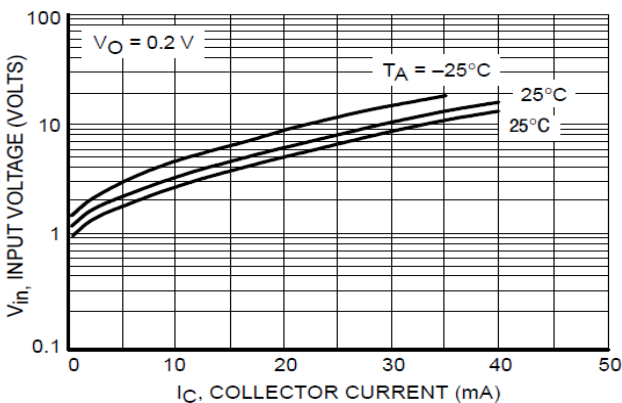



**MUN2214**

17.  $V_{CE(sat)}$  vs.  $I_C$

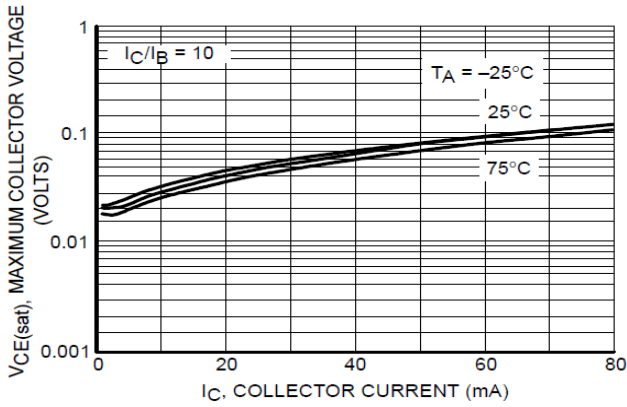

18. DC Current Gain

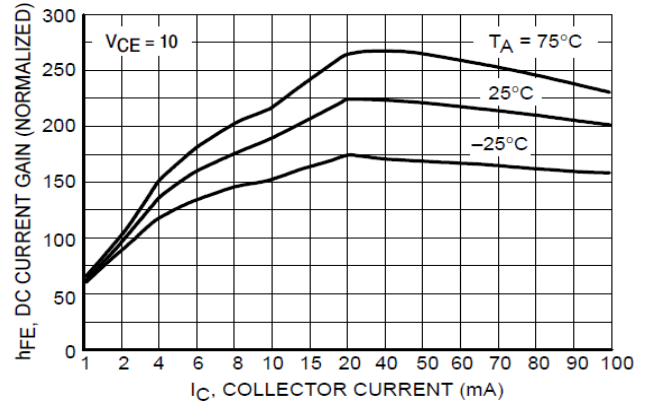

19. Output Capacitance

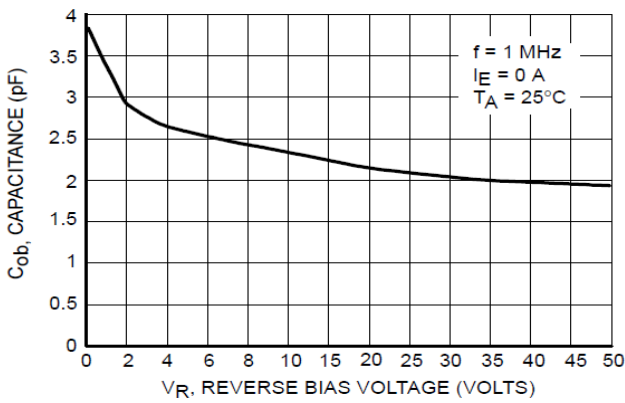

20. Output Current vs. Input Voltage

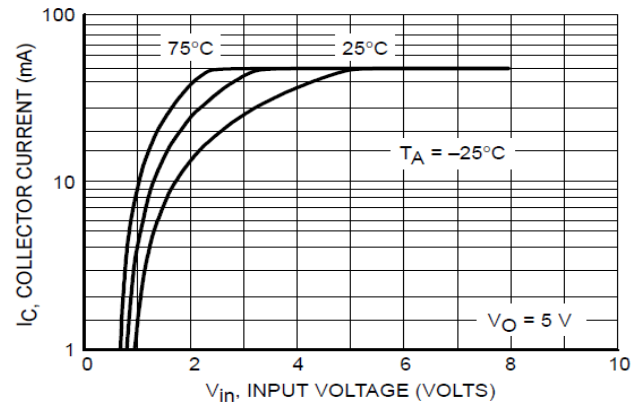

21. Input Voltage vs. Output Current

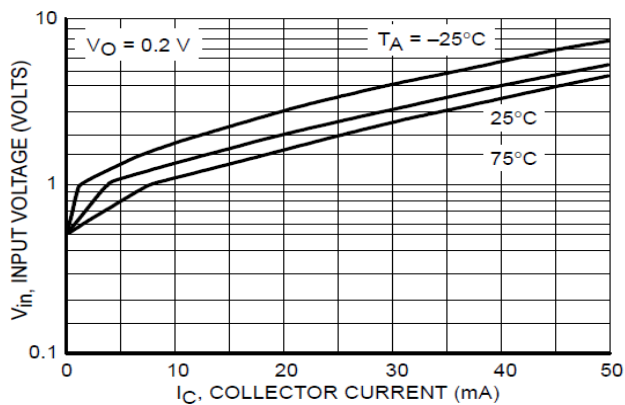



**MUN2215**

22.  $V_{CE(sat)}$  versus  $I_C$

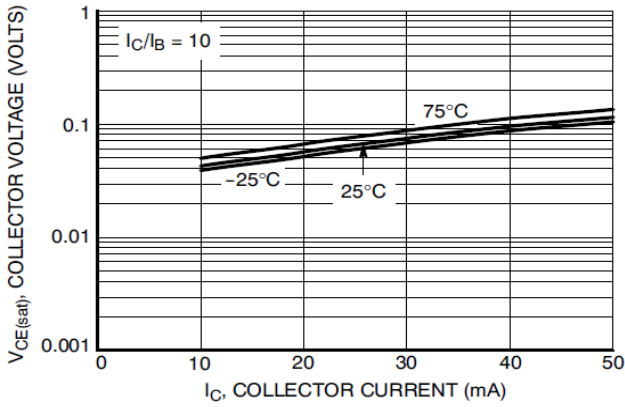

23. DC Current Gain

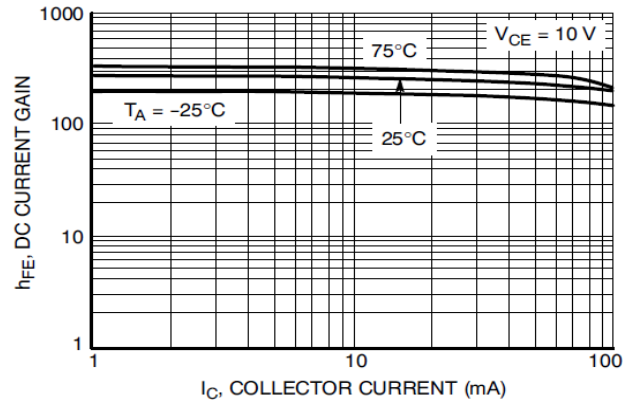

24. Output Capacitance

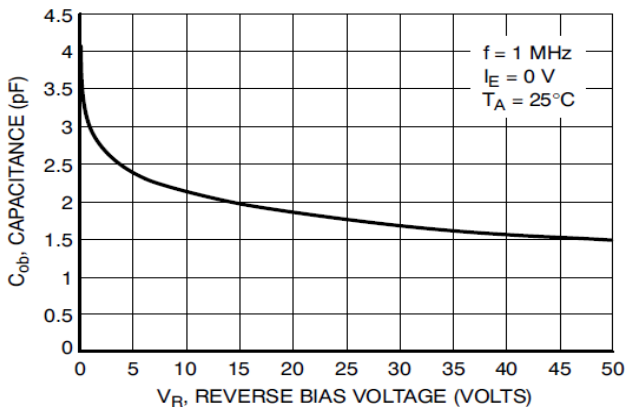

25. Output Current versus Input Voltage

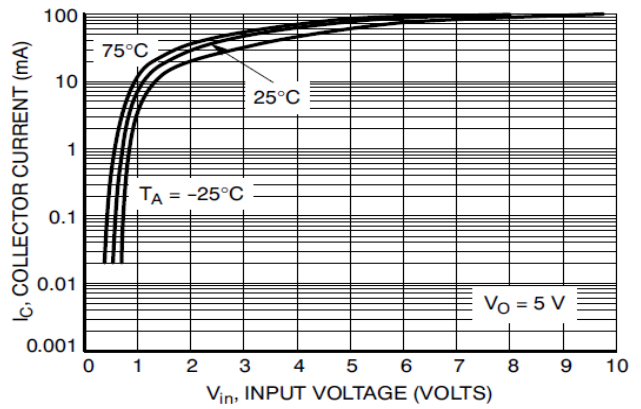

26. Input Voltage versus Output Current

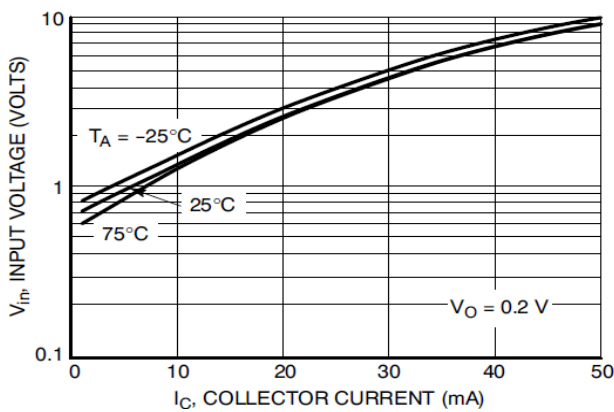



**MUN2216**

27.  $V_{CE(sat)}$  versus  $I_C$

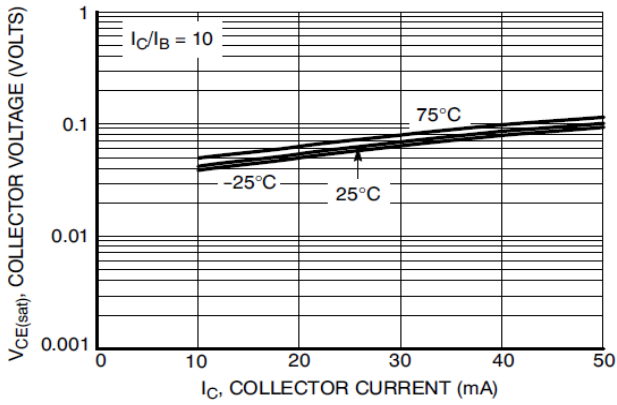

28. DC Current Gain

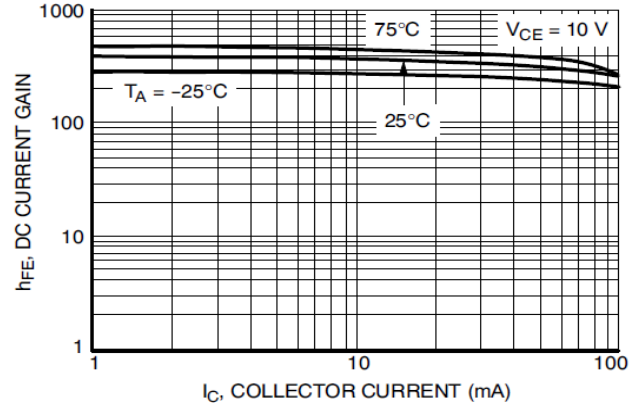

29. Output Capacitance

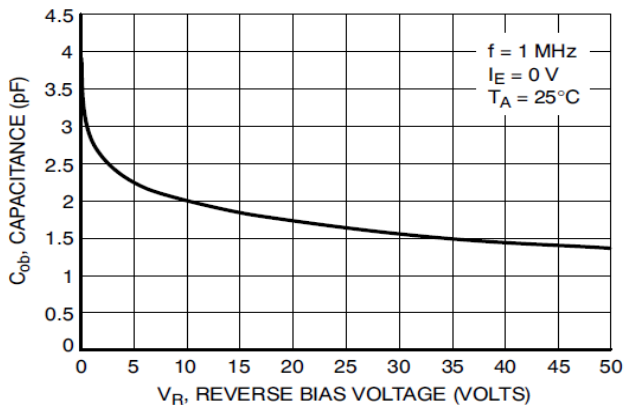

30. Output Current versus Input Voltage

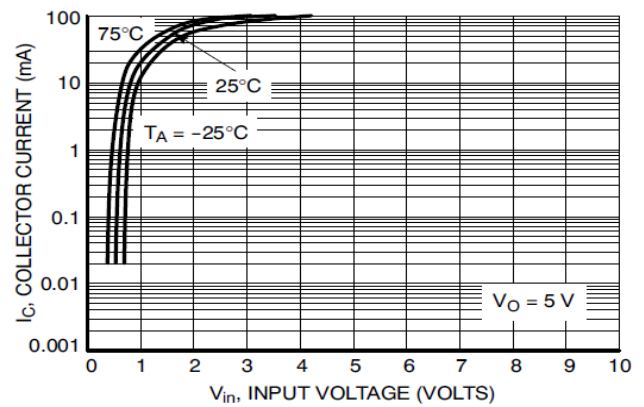

31. Input Voltage versus Output Current

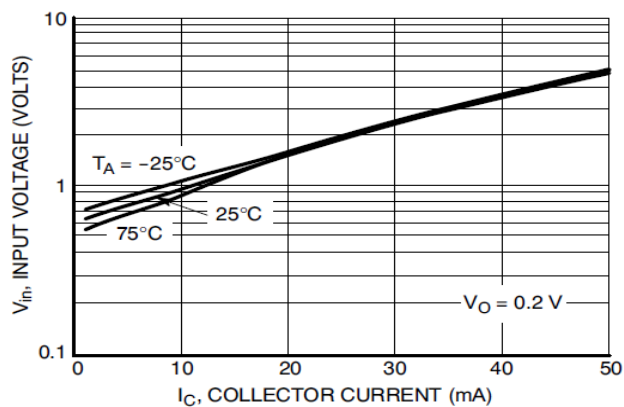



**MUN2230**

32.  $V_{CE(sat)}$  versus  $I_C$

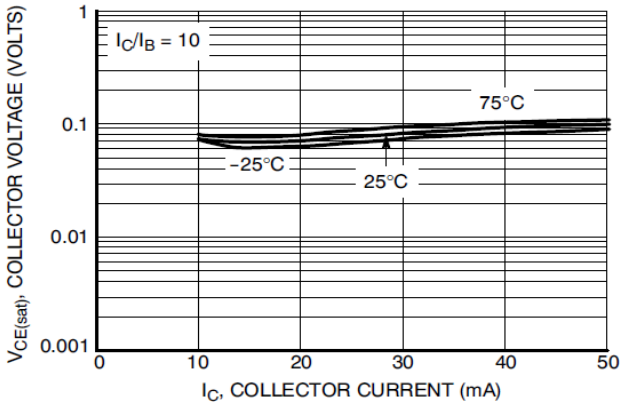

33. DC Current Gain

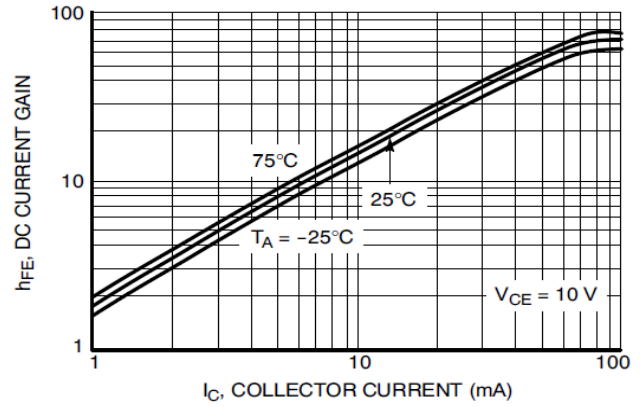

34. Output Capacitance

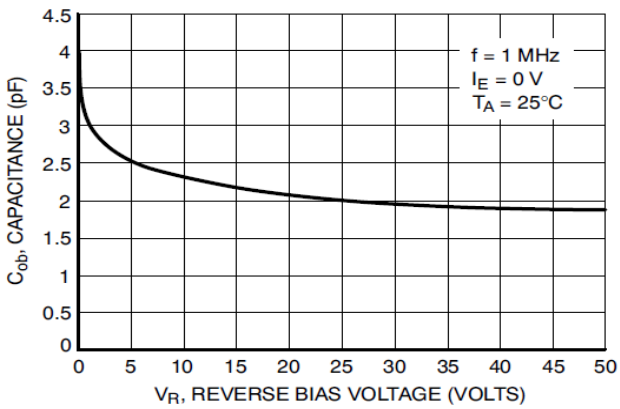

35. Output Current versus Input Voltage

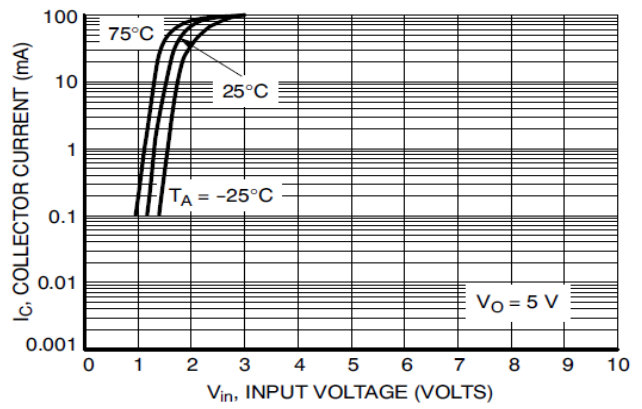

36. Input Voltage versus Output Current

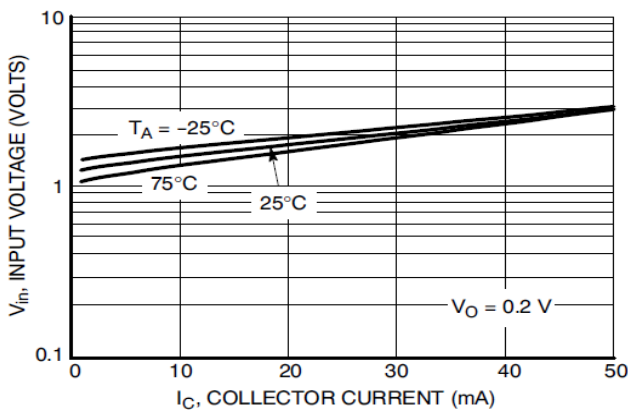



**MUN2231**

37.  $V_{CE(sat)}$  versus  $I_C$

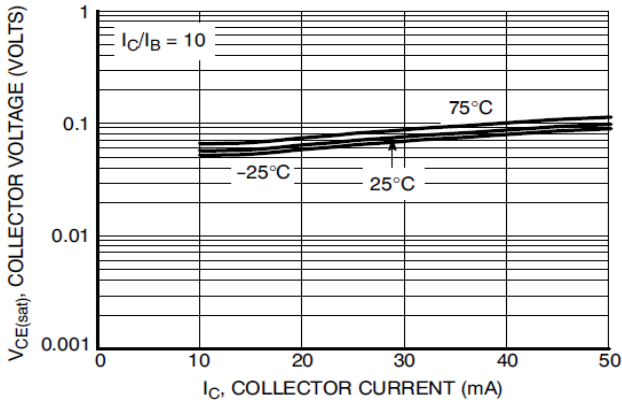

38. DC Current Gain

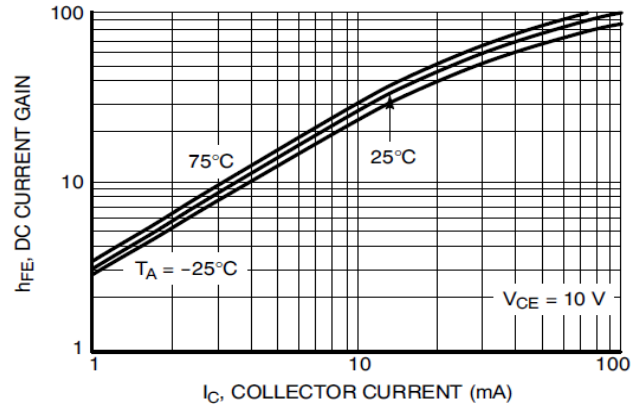

39. Output Capacitance

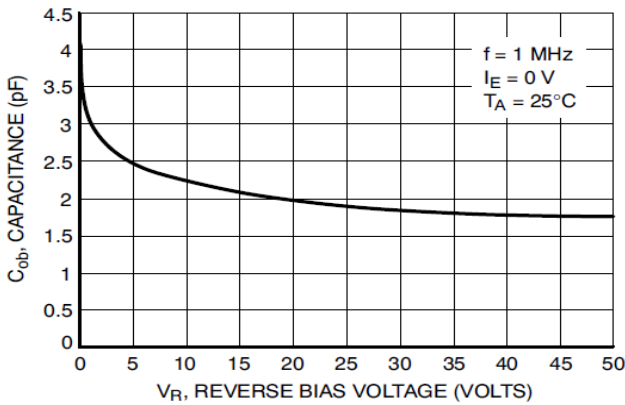

40. Output Current versus Input Voltage

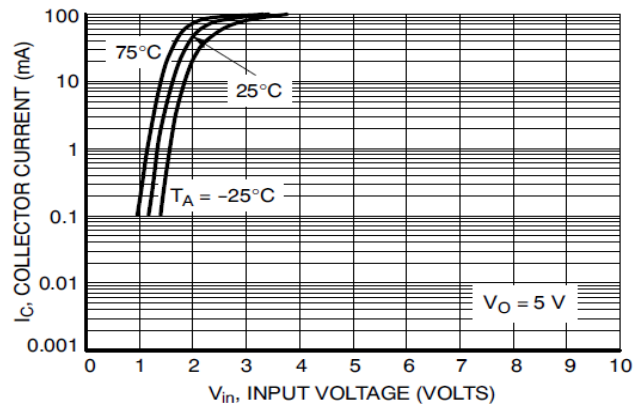

41. Input Voltage versus Output Current

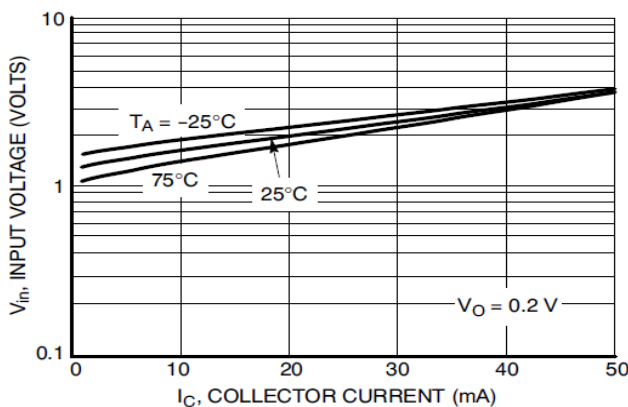



**MUN2232**

42.  $V_{CE(sat)}$  vs.  $I_C$

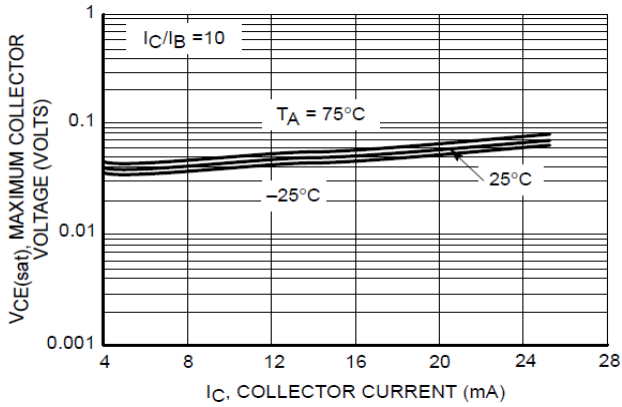

43. DC Current Gain

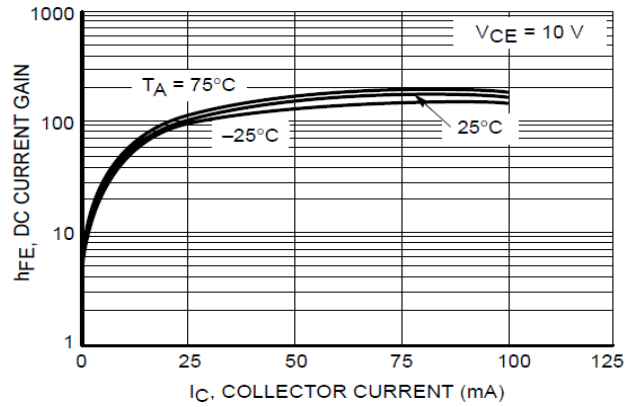

44. Output Capacitance

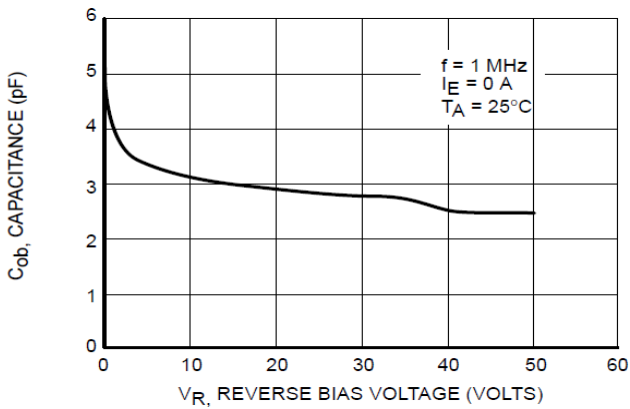

45. Output Current vs. Input Voltage

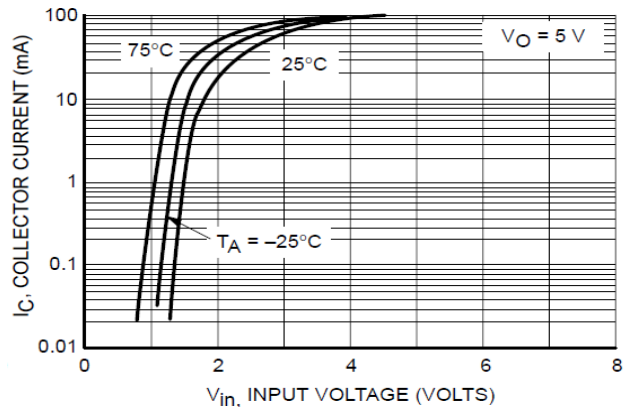

46. Output Voltage vs. Input Current

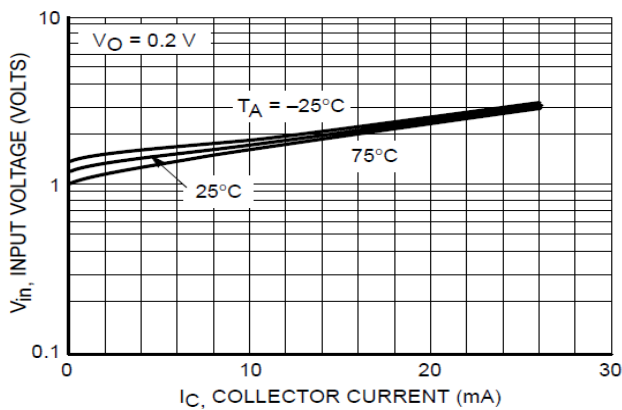



**MUN2233**

47.  $V_{CE(sat)}$  vs.  $I_C$

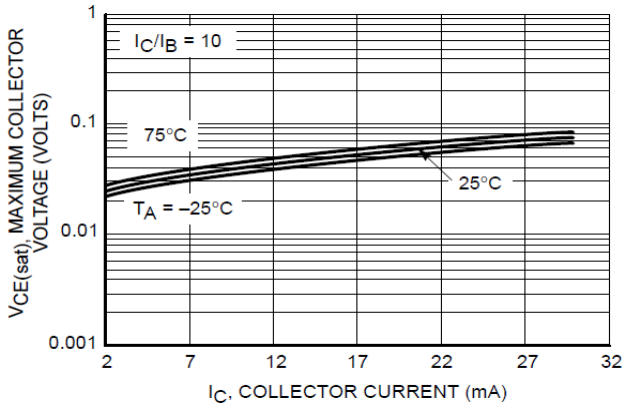

48. DC Current Gain

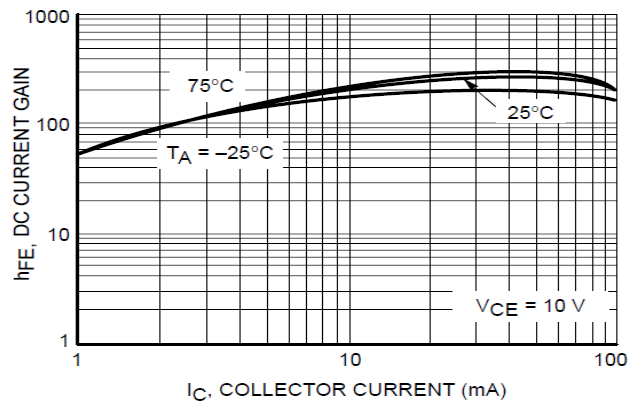

49. Figure 49. Output Capacitance

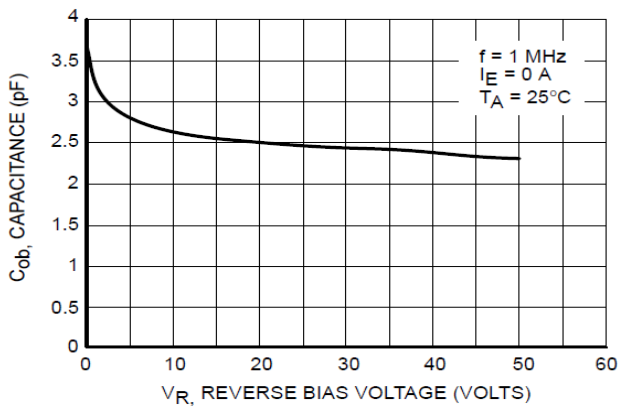

50. Figure 50. Output Current vs. Input Voltage

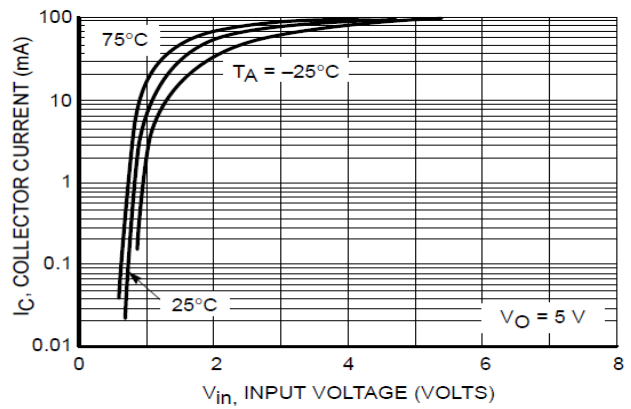

51. Input Voltage vs. Output Current

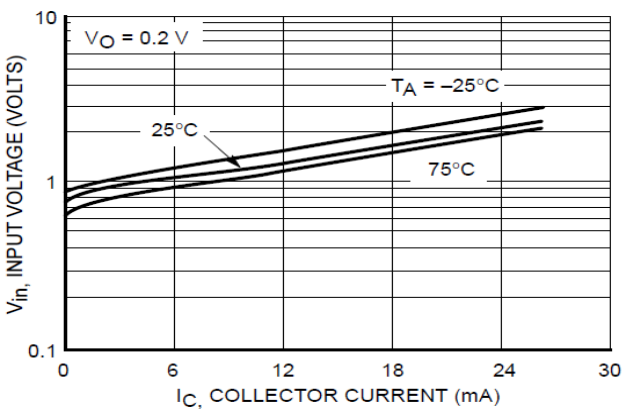





**MUN2234**

52. Input voltage vs. output current  
(ON characteristics)

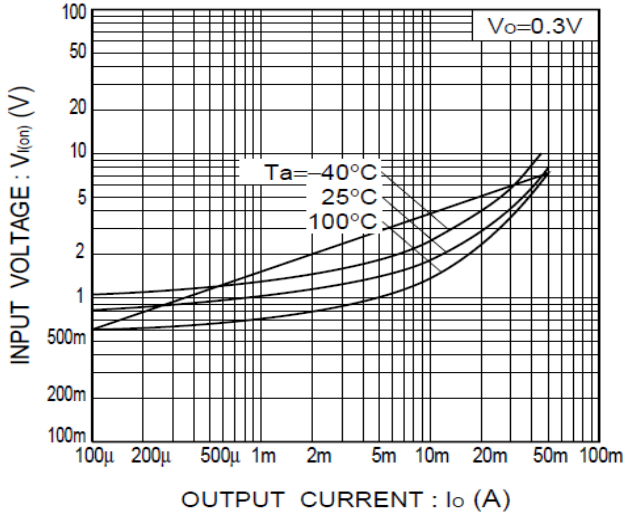

53. Output current vs. input voltage  
(OFF characteristics)

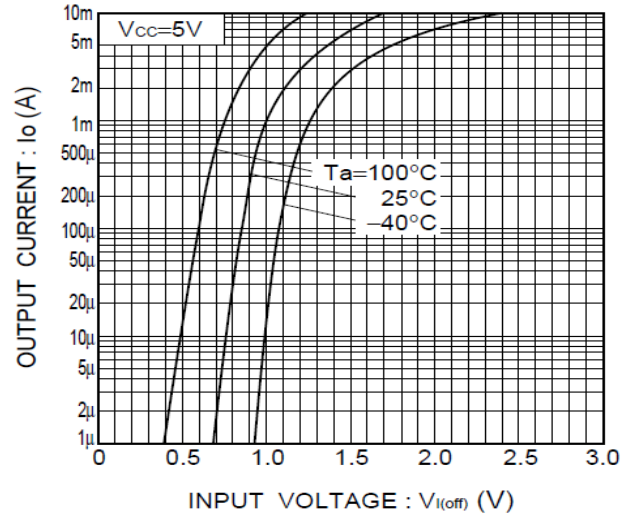

54. DC current gain vs. output current

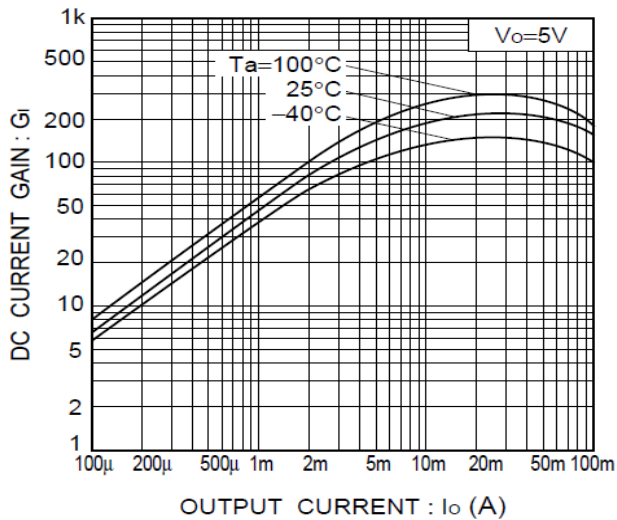

55. Output voltage vs. output current

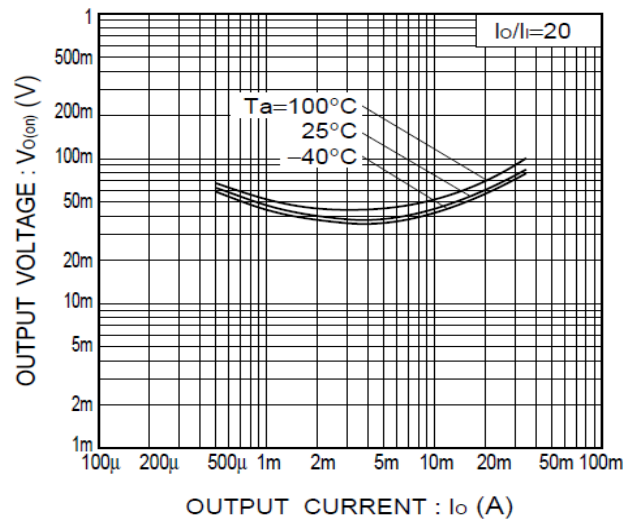



**NPN BRTs**

56. Level Shifter: Connects 12 or 24 Volt Circuits to Logic

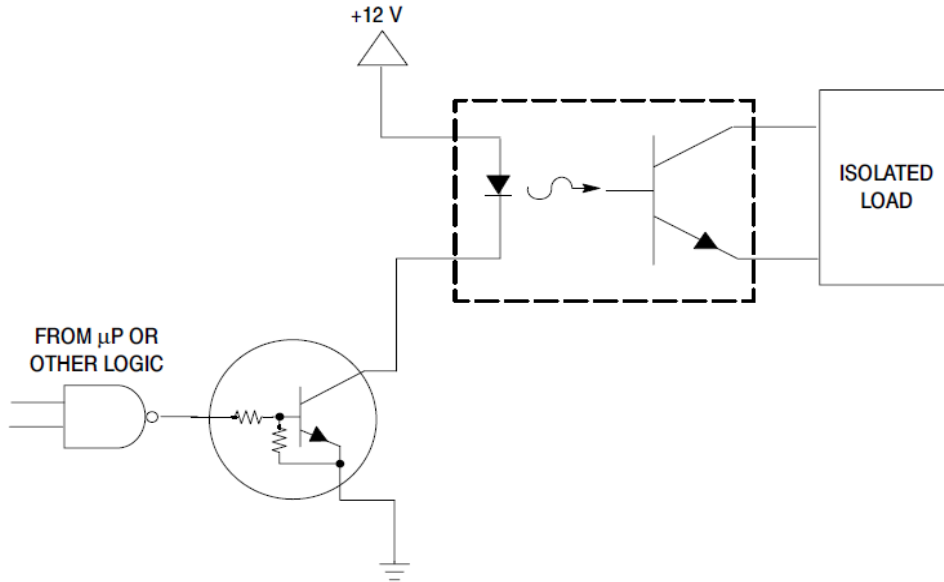

57. Open Collector Inverter: Inverts the Input Signal

58. Inexpensive, Unregulated Current Source

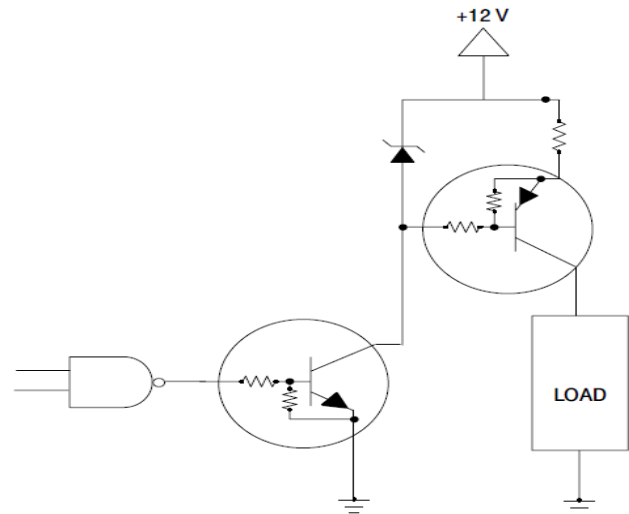
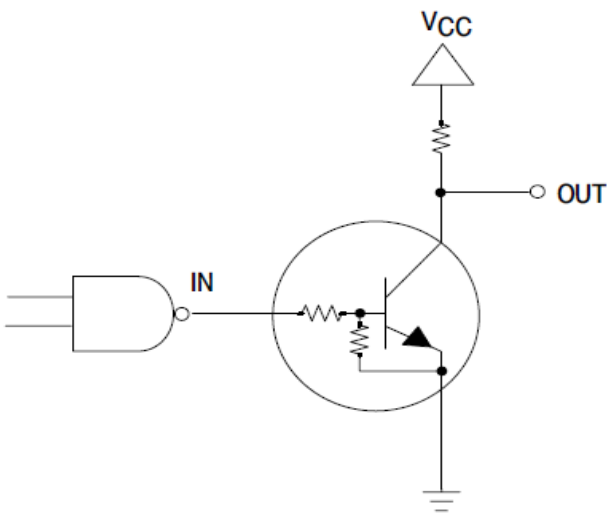



**PACKAGE INFORMATION**

Dimension in SOT-23 Package (Unit: mm)

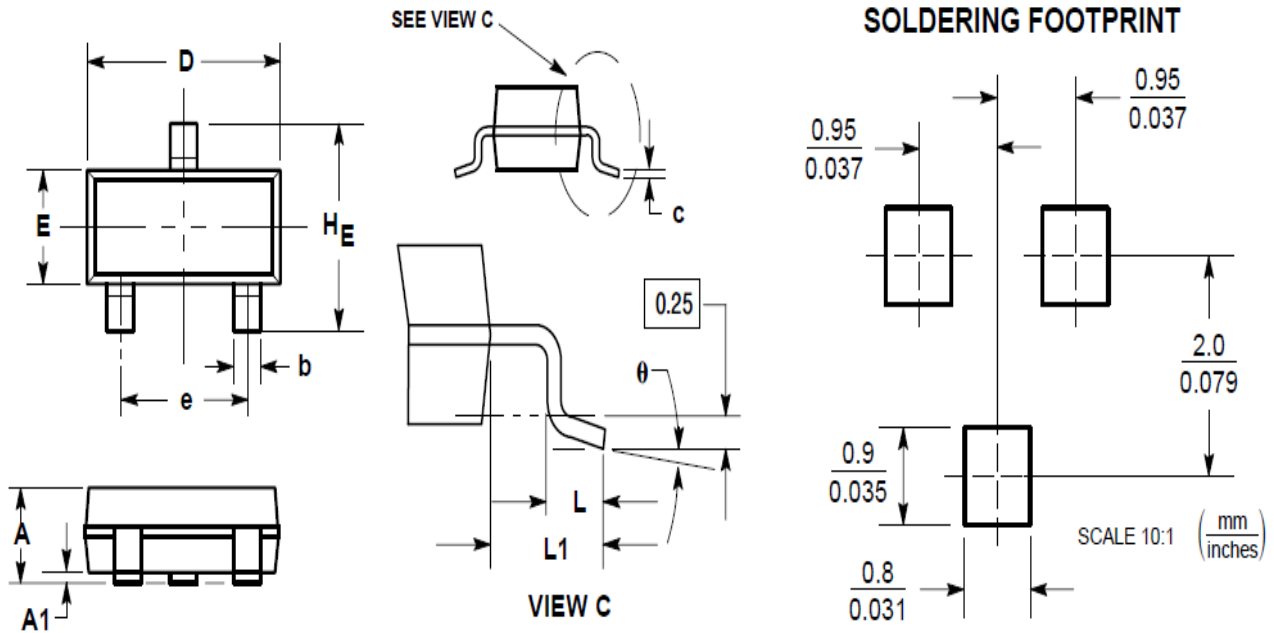

DIM	INCHES		MILLIMETERS	
	MIN	MAX	MIN	MAX
A	0.035	0.044	0.89	1.11
A1	0.001	0.004	0.01	0.10
b	0.015	0.020	0.37	0.50
c	0.003	0.007	0.09	0.18
D	0.110	0.120	2.80	3.04
E	0.047	0.055	1.20	1.40
e	0.070	0.081	1.78	2.04
L	0.004	0.012	0.10	0.30
L1	0.014	0.029	0.35	0.69
H <sub>E</sub>	0.083	0.104	2.10	2.64



## IMPORTANT NOTICE

AiT Semiconductor Inc. (AiT) reserves the right to make changes to any its product, specifications, to discontinue any integrated circuit product or service without notice, and advises its customers to obtain the latest version of relevant information to verify, before placing orders, that the information being relied on is current.

AiT Semiconductor Inc.'s integrated circuit products are not designed, intended, authorized, or warranted to be suitable for use in life support applications, devices or systems or other critical applications. Use of AiT products in such applications is understood to be fully at the risk of the customer. As used herein may involve potential risks of death, personal injury, or severe property, or environmental damage. In order to minimize risks associated with the customer's applications, the customer should provide adequate design and operating safeguards.

AiT Semiconductor Inc. assumes to no liability to customer product design or application support. AiT warrants the performance of its products of the specifications applicable at the time of sale.