



DESCRIPTION

The ESD5Z2.5/3.3/5.0/6.0/7.0/12 Series is designed to protect voltage sensitive components from ESD and transient voltage events. Excellent clamping capability, low leakage, and fast response time, make these parts ideal for ESD protection on designs where board space is at a premium.

The ESD5Z2.5/3.3/5.0/6.0/7.0/12 is available in SOD-523 Package.

ORDERING INFORMATION

Package Type	Part Number
SOD-523	ESD5Z2.5
	ESD5Z3.3
	ESD5Z5.0
	ESD5Z6.0
	ESD5Z7.0
	ESD5Z12
Note	SPQ: 3,000pcs/Reel
AiT provides all RoHS Compliant Products	

FEATURES

- Small Body Outline Dimensions
- Low Body Height
- Stand-off Voltage: 2.5V – 12V
- Peak Power up to 200Watts @ 8/20 μ s Pulse
- Low Leakage
- Response Time is Typically <1 ns
- ESD Rating of Class 3 (> 16kV) per Human Body Model
- IEC61000-4-2 Level 4 ESD Protection
- IEC61000-4-4 Level 4 EFT Protection
- Available in SOD-523 Package

APPLICATIONS

- Cellular phones
- Portable devices
- Digital cameras
- Power supplies

PIN DESCRIPTION

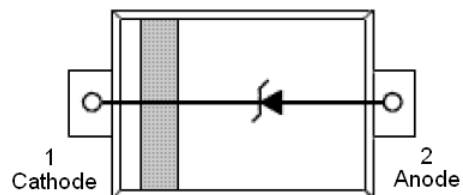



ABSOLUTE MAXIMUM RATINGS

T_{amb} = 25°C

P _{PP} , Peak Pulse Power (t _p = 8/20μs)		200W
T _L , Maximum Lead Temperature for Soldering During 10s		260°C
T _{STG} , Storage Temperature Range		-55°C ~ +150°C
T _{OP} , Operating Temperature Range		-40°C ~ +125°C
T _J , Maximum Junction Temperature		150°C
IEC61000-4-2 (ESD)	Air discharge	±15kV
	Contact discharge	±8kV
IEC61000-4-4 (EFT)		40A
ESD Voltage	Per Human Body Model	16kV

Stresses above may cause permanent damage to the device. These are stress ratings only and functional operation of the device at these or any other conditions beyond those indicated in the Electrical Characteristics are not implied. Exposure to absolute maximum rating conditions for extended periods may affect device reliability.



ELECTRICAL PARAMETER

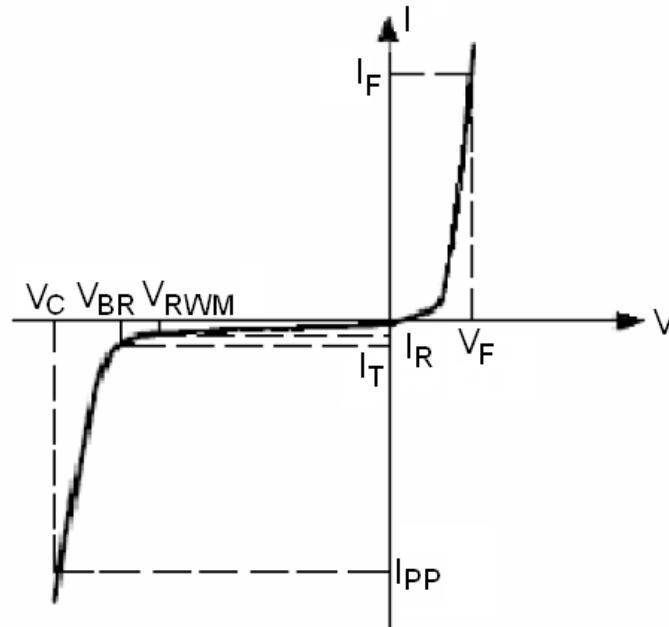

Symbol	Parameter
I_{PP}	Maximum Reverse Peak Pulse Current
V_C	Clamping Voltage @ I_{PP}
V_{RWM}	Working Peak Reverse Voltage
I_R	Maximum Reverse Leakage Current @ V_{RWM}
I_T	Test Current
V_{BR}	Breakdown Voltage @ I_T
I_F	Forward Current
V_F	Forward Voltage @ I_F



ELECTRICAL CHARACTERISTICS

Ratings at 25°C ambient temperature unless otherwise specified. $V_F = 0.9V$ at $I_F = 10mA$

Part Number	$V_{RWM}(V)$	$I_R(\mu A)$ @ V_{RWM}	$V_{BR}(V)$ @ I_T NOTE1	I_T	$V_C(V)$ @ $I_{PP}=5A$ NOTE2	$V_C(V)$ @ Max I_{PP} NOTE2	$I_{PP}(A)$ NOTE2	$P_{PK}(W)$ NOTE2	$C(pF)$
	MAX	MAX	MIN	mA	TYP	MAX	MAX	MAX	TYP
ESD5Z2.5	2.5	6.0	4.0	1.0	6.5	10.9	11.0	120	145
ESD5Z3.3	3.3	1.0	5.0	1.0	8.4	14.1	11.2	158	105
ESD5Z5.0	5.0	1.0	6.2	1.0	11.6	18.6	9.4	174	80
ESD5Z6.0	6.0	1.0	6.8	1.0	12.4	20.5	8.8	181	70
ESD5Z7.0	7.0	1.0	7.5	1.0	13.5	22.7	8.8	200	65
ESD5Z12	12	1.0	13.5	1.0	17	25	9.6	240	55

NOTE1: V_{BR} is measured with a pulse test current I_T at an ambient temperature of 25°C .

NOTE2: Surge current waveform per Figure 1.



TYPICAL CHARACTERISTICS

Figure 1. Pulse Waveform

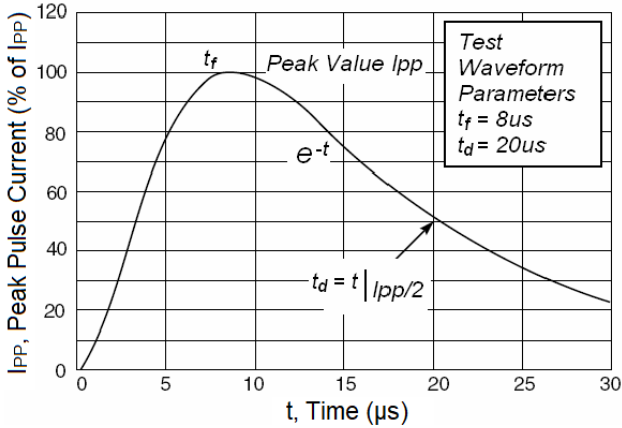
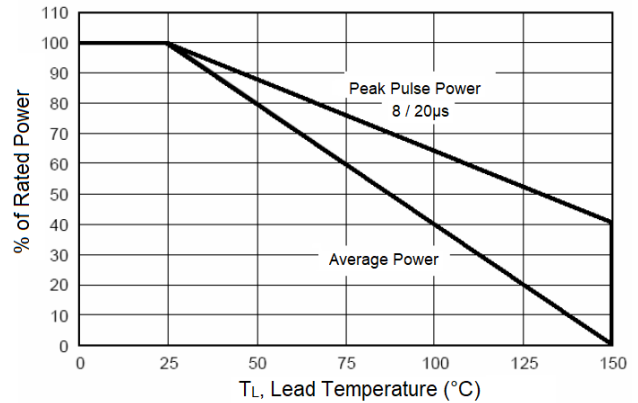

Figure 2. Power Derating



APPLICATION NOTE

Electrostatic discharge (ESD) is a major cause of failure in electronic systems. Transient Voltage Suppressors (TVS) are an ideal choice for ESD protection. They are capable of clamping the incoming transient to a low enough level such that damage to the protected semiconductor is prevented.

Surface mount TVS offer the best choice for minimal lead inductance. They serve as parallel protection elements, connected between the signal line to ground. As the transient rises above the operating voltage of the device, the TVS becomes a low impedance path diverting the transient current to ground. The ESD5Z2.5/3.3/5.0/6.0/7.0/12 is the ideal board level protection of ESD sensitive semiconductor components. The tiny SOD-523 package allows design flexibility in the design of high density boards where the space saving is at a premium. This enables to shorten the routing and contributes to hardening against ESD.

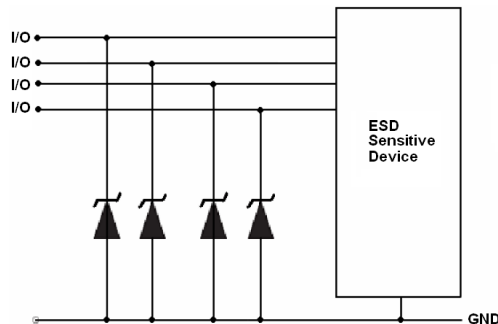



PACKAGE INFORMATION

Dimension in SOD-523 Package (Unit: mm)

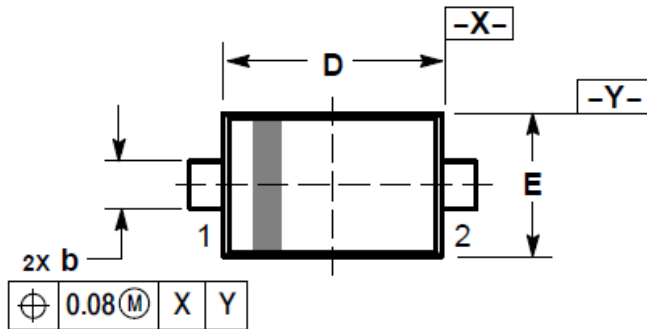

TOP VIEW

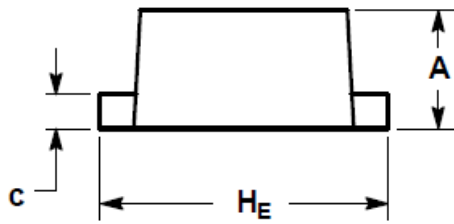

SIDE VIEW

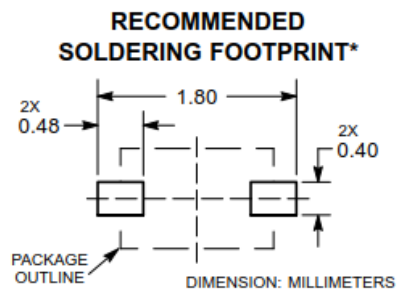

DIM	MIN	MAX
A	0.50	0.70
b	0.25	0.35
c	0.07	0.20
D	1.10	1.30
E	0.70	0.90
H _E	1.50	1.70
L	0.30 REF	
L2	0.15	0.25



IMPORTANT NOTICE

AiT Semiconductor Inc. (AiT) reserves the right to make changes to any its product, specifications, to discontinue any integrated circuit product or service without notice, and advises its customers to obtain the latest version of relevant information to verify, before placing orders, that the information being relied on is current.

AiT Semiconductor Inc.'s integrated circuit products are not designed, intended, authorized, or warranted to be suitable for use in life support applications, devices or systems or other critical applications. Use of AiT products in such applications is understood to be fully at the risk of the customer. As used herein may involve potential risks of death, personal injury, or server property, or environmental damage. In order to minimize risks associated with the customer's applications, the customer should provide adequate design and operating safeguards.

AiT Semiconductor Inc. assumes to no liability to customer product design or application support. AiT warrants the performance of its products of the specifications applicable at the time of sale.