



DESCRIPTION

The A6500B is designed for portable applications with demanding performance and space requirements. The A6500B performance is optimized for battery-powered systems to deliver ultra-low noise and low quiescent current. Regulator ground current increases only slightly in dropout, further prolonging the battery life. The A6500B also works with low-ESR ceramic capacitors, reducing the amount of board space necessary for power applications, critical in hand-held wireless devices. The A6500B consumes only 0.1 μ A current in shutdown mode and has fast turn-on time (Typical 100 μ s). The other features include ultra-low dropout voltage, high output accuracy, current limiting protection, and high ripple rejection ratio.

A6500B is available in SOT-25 and DFN4 (1x1) packages.

ORDERING INFORMATION

Package Type	Part Number	
SOT-25 SPQ: 3,000pcs/Reel	E5	A6500BE5R-XX
		A6500BE5VR-XX
DFN4(1x1) SPQ: 5,000pcs/Reel	J4	A6500BJ4R-XX
		A6500BJ4VR-XX
Note	XX: Output Voltage 10=1.0V, 33=3.3V V: Halogen free Package R: Tape & Reel	
AiT provides all RoHS products		

FEATURES

- Ultra-low Noise
- Ultra-Fast Transient Response
- High PSRR: -87dB @ 217Hz
-83dB @ 1kHz
-54dB @ 1MHz
- 0.1 μ A Standby Current When Shutdown
- Low Dropout: 240mV@500mA ($V_{OUT}=2.8V$)
- Wide Operating Voltage Ranges: 1.8V to 5.5V
- Current Limiting and Short Circuit Current Protection
- Thermal Shutdown Protection
- Only 1 μ F Output Capacitor Required for Stability
- Fast output discharge
- Available in SOT-25 and DFN4 (1x1) packages

APPLICATION

- Cellular and Smart Phones
- Cordless Telephones
- Camera and Machine Vision Modules
- Battery-Powered Equipment
- Laptop, Palmtops, Notebook Computers
- Hand-Held Instruments

TYPICAL APPLICATION CIRCUIT

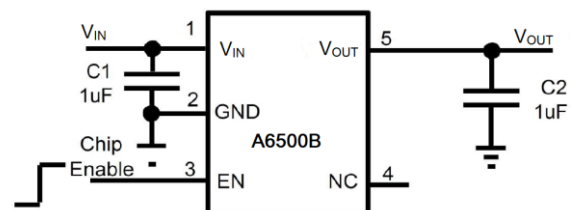



PIN DESCRIPTION

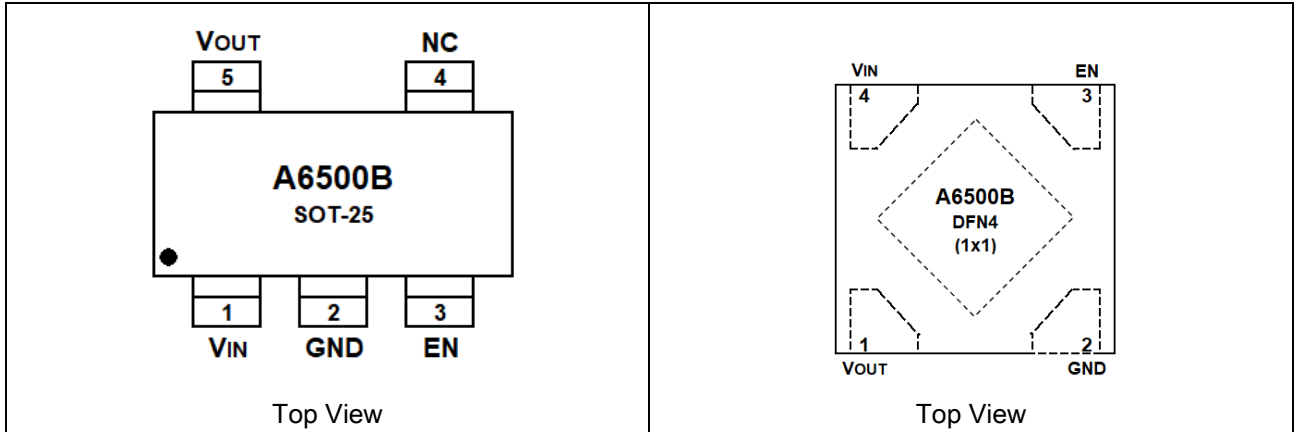

Pin #		Symbol	Function
SOT-25	DFN4(1x1)		
1	4	V_{IN}	Power Input Voltage
2	2	GND	Ground
3	3	EN	Chip Enable Pin. This pin has an internal pull-down resistor
4	-	NC	No Connection
5	1	V_{OUT}	Output Voltage
-	Exposed Pad	-	The exposed pad should be connected to a large ground plane to maximize thermal performance



ABSOLUTE MAXIMUM RATINGS

V_{IN} , Input Supply Voltage	-0.3V ~ +6V
EN Pin Input Voltage	-0.3V ~ V_{IN}
Output Voltages	-0.3V ~ $V_{IN}+0.3V$
Output Current	500mA
Maximum Junction Temperature	150°C
Operating Temperature Range ^{NOTE1}	-40°C ~ 85°C
Storage Temperature Range	-65°C ~ 125°C
Lead Temperature (Soldering, 10s)	300°C

Stresses above may cause permanent damage to the device. These are stress ratings only and functional operation of the device at these or any other conditions beyond those indicated in the Electrical Characteristics are not implied. Exposure to absolute maximum rating conditions for extended periods may affect device reliability.

NOTE1: The A6500B is guaranteed to meet performance specifications from 0°C to 70°C. Specifications over the -40°C to 85°C operating temperature range are assured by design, characterization and correlation with statistical process controls.

THERMAL RESISTANCE^{NOTE2}

Package	θ_{JA}	θ_{JC}
SOT-25	250°C/W	130°C/W

NOTE2: Thermal Resistance is specified with approximately 1 square of 1 oz copper.



ELECTRICAL CHARACTERISTICS^{NOTE3}

$V_{IN}=V_{OUT}+1V$, $EN=V_{IN}$, $C_{IN}=C_{OUT}=1\mu F$, $T_A=25^\circ C$, unless otherwise noted.

Parameter	Symbol	Conditions	Min.	Typ.	Max.	Unit	
Input Voltage	V_{IN}		1.8	-	5.5	V	
Output Voltage Accuracy	ΔV_{OUT}	$V_{IN}=V_{OUT}+1V$, $I_{OUT}=1mA$	-2	-	+2	%	
Current Limit	I_{LIM}	$R_{LOAD}=1\Omega$	550	-	-	mA	
Short Circuit Current	I_{SHORT}	$V_{OUT}=0V$	-	200	-	mA	
Quiescent Current	I_Q	$V_{EN}>1.2V$, $I_{OUT}=0mA$	-	45	70	μA	
Dropout Voltage	V_{DROP}	$I_{OUT}=500mA$, $V_{OUT}=3.3V$	-	220	320	mV	
		$I_{OUT}=500mA$, $V_{OUT}=2.8V$	-	240	360		
		$I_{OUT}=500mA$, $V_{OUT}=1.8V$	-	360	520		
		$I_{OUT}=500mA$, $V_{OUT}=1.0V$	-	700	1000		
Line Regulation ^{NOTE4}	ΔV_{LINE}	$V_{IN}=V_{OUT}+1V$ to 5.5V $I_{OUT}=1mA$	-	0.03	0.17	%/V	
Load Regulation ^{NOTE5}	ΔV_{LOAD}	$1mA < I_{OUT} < 300mA$ $V_{IN}=V_{OUT}+1V$	-	0.002	-	%mA	
Output Voltage Temperature Coefficient ^{NOTE6}	TC_{VOUT}	$I_{OUT}=1mA$	-	± 60	-	ppm/ $^\circ C$	
Standby Current	I_{STBY}	$V_{EN}=GND$, Shutdown	-	0.1	1	μA	
EN Input Bias Current	I_{IBSD}	$V_{EN}=GND$ or V_{IN}	-	0.1	1	μA	
EN Input Threshold	Logic Low	V_{IL}	$V_{IN}=3V$ to 5.5V, Shutdown	-	-	0.4	V
	Logic High	V_{IH}	$V_{IN}=3V$ to 5.5V, Start up	1.2	-	-	
Output Noise Voltage	e_{NO}	10 to 100kHz; $C_{OUT}=1\mu F$ $I_{OUT}=100mA$; $V_{OUT}=2.8V$	-	50	-	μV_{RMS}	
		10 to 100kHz; $C_{OUT}=1\mu F$ $I_{OUT}=100mA$; $V_{OUT}=1.8V$	-	38	-		
Power Supply Rejection Ratio	f=217Hz	PSRR	$I_{OUT}=10mA$, $V_{OUT}=1.8V$, $V_{IN}=2.8V$	-	-87	-	dB
	f=1kHz			-	-83	-	
	f=10kHz			-	-72	-	
	f=1MHz			-	-54	-	
Thermal Shutdown Temperature	T_{SD}	Shutdown, Temp increasing	-	170	-	$^\circ C$	
Thermal Shutdown Hysteresis	T_{SDHY}		-	25	-	$^\circ C$	

NOTE4: Production test at +25 $^\circ C$. Specifications over the temperature range are guaranteed by design and characterization.

NOTE5: Line regulation is calculated by $\gamma \Delta V_{LINE} = [(V_{OUT1}-V_{OUT2})/(\Delta V_{IN} \times V_{OUT(normal)})] \times 100$

Where V_{OUT1} is the output voltage when $V_{IN}=5.5V$, and V_{OUT2} is the output voltage when $V_{IN}=4.3V$, $\Delta V_{IN}=1.2V$. $V_{OUT(normal)}=3.3V$.

NOTE6: Load regulation is calculated by $\Delta V_{LOAD} = [(V_{OUT1}-V_{OUT2})/(\Delta I_{OUT} \times V_{OUT(normal)})] \times 100$

Where V_{OUT1} is the output voltage when $I_{OUT}=1mA$, and V_{OUT2} is the output voltage when $I_{OUT}=300mA$. $\Delta I_{OUT}=299mA$, $V_{OUT(normal)}=2.8V$.

NOTE7: The temperature coefficient is calculated by $TC_{VOUT} = \Delta V_{OUT} / (\Delta T \times V_{OUT})$



TYPICAL PERFORMANCE CHARACTERISTICS

1. Quiescent Current vs Temperature

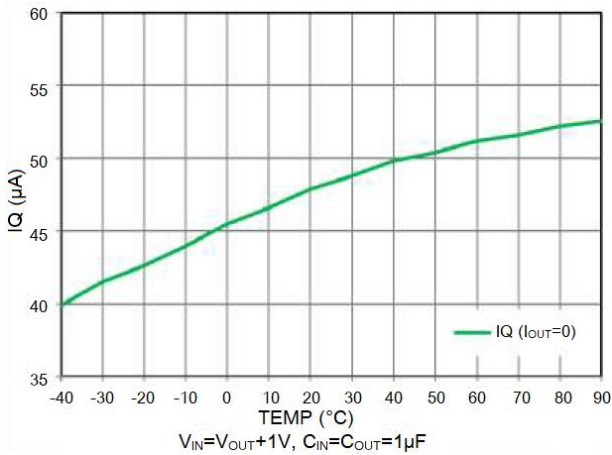

2. Dropout Voltage vs. Output Voltage

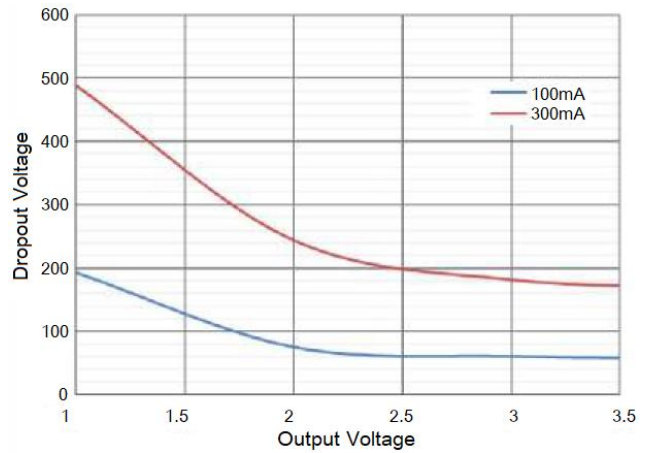

3. Output Dropout Voltage vs Load Current ($V_{OUT}=2.8V$)

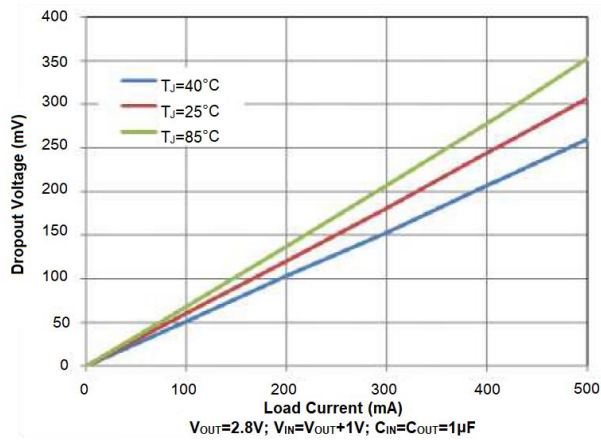

4. Dropout Voltage vs Load Current ($V_{OUT}=1.8V$)

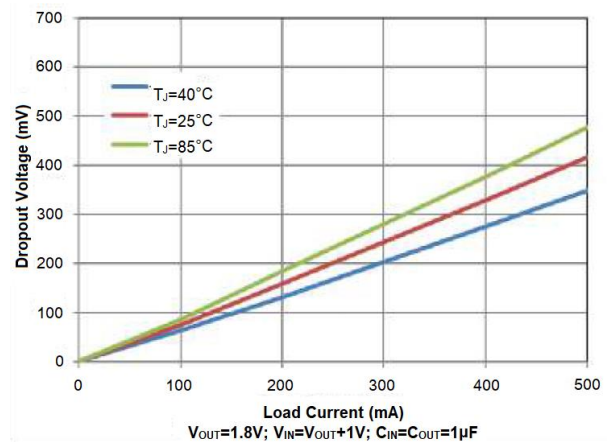

5. Power-Supply Ripple Rejection vs Frequency ($V_{OUT}=2.8V$)

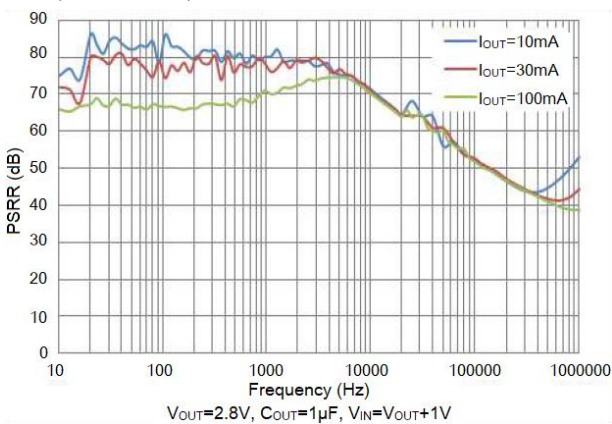

6. Power-Supply Ripple Rejection vs. Frequency ($V_{OUT}=1.8V$)

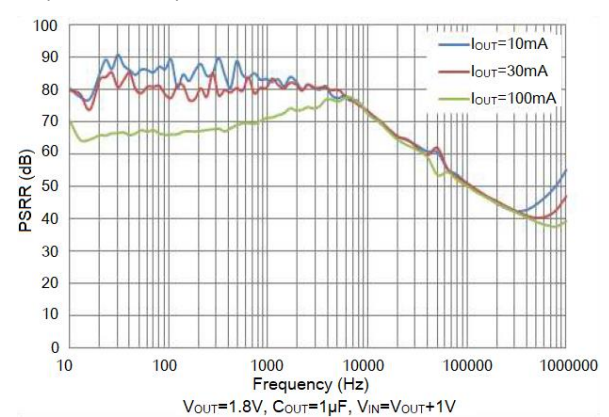



7. EN Start ($V_{OUT}=1.8V$)

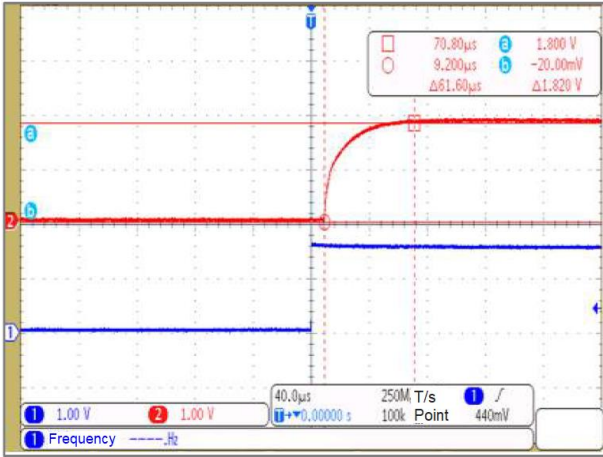

8. EN Shutdown ($V_{OUT}=1.8V$)

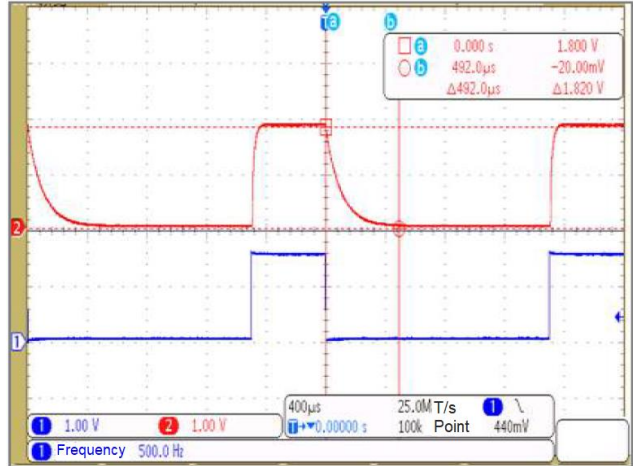

9. Load Trans 1mA~300mA ($V_{OUT}=1.8V$)

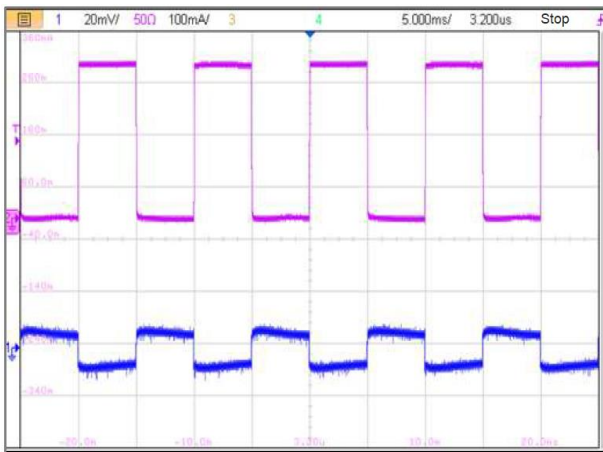

10. Load Trans 1mA~300mA ($V_{OUT}=2.8V$)

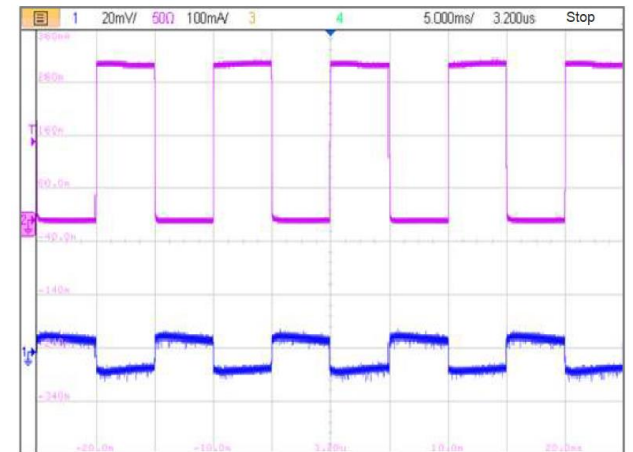

11. Line Trans 2.8V~5.5V ($V_{OUT}=1.8V, I_{OUT}=1mA$)

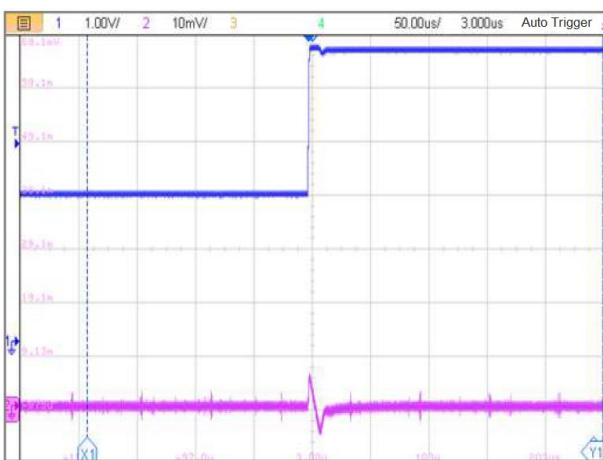

12. Line Trans 3.8V~5.5V ($V_{OUT}=2.8V, I_{OUT}=1mA$)

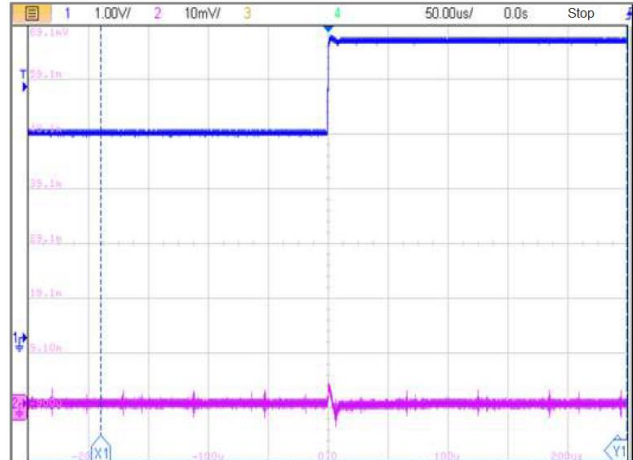



BLOCK DIAGRAM

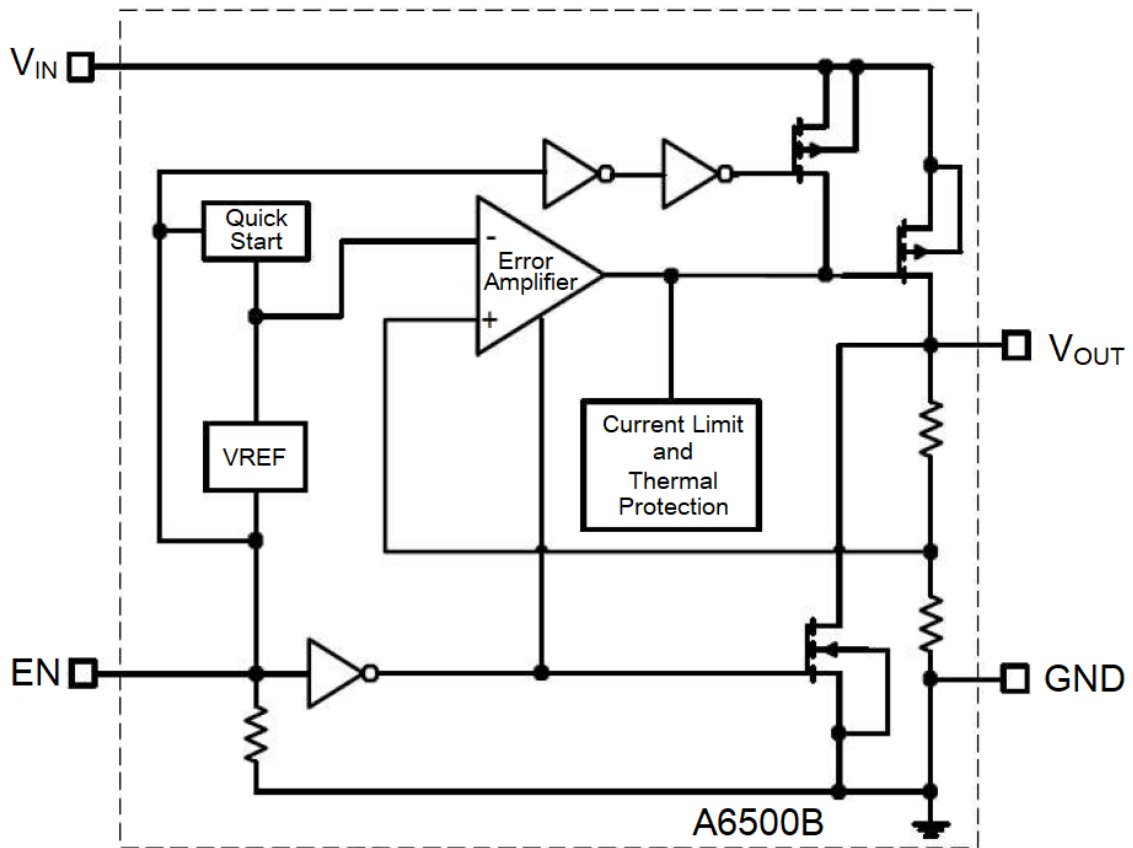



DETAILED INFORMATION

Applications Information

Like any low-dropout regulator, the external capacitors used with the A6500B must be carefully selected for regulator stability and performance. Using a capacitor whose value is $> 1\mu\text{F}$ on the A6500B input and the amount of capacitance can be increased without limit. The input capacitor must be located a distance of not more than 0.5 inch from the input pin of the IC and returned to a clean analog ground. Any good quality ceramic or tantalum can be used for this capacitor. The capacitor with larger value and lower ESR (equivalent series resistance) provides better PSRR and line-transient response. The output capacitor must meet both requirements for minimum amount of capacitance and ESR in all LDOs application. Generally, $1.0\text{-}\mu\text{F}$ X7R-type ceramic capacitors are recommended because these capacitors have minimal variation in value and equivalent series resistance (ESR) over temperature. Output capacitor of larger capacitance can reduce noise and improve load transient response, stability and PSRR. The output capacitor should be located not more than 0.5 inch from the V_{OUT} pin of the A6500B and returned to a clean analog ground.

Enable Function

The A6500B features an LDO regulator enable/disable function. To assure the LDO regulator will switch on; the EN turn on control level must be greater than 1.2 volts. The LDO regulator will go into the shutdown mode when the voltage on the EN pin falls below 0.4 volts. For to protect the system, the A6500B have a quick discharge function. If the enable function is not needed in a specific application, it may be tied to V_{IN} to keep the LDO regulator in a continuously on state.

Thermal Considerations

Thermal protection limits power dissipation in A6500B. When the operation junction temperature exceeds 170°C , the OTP circuit starts the thermal shutdown function turn the pass element off. The pass element turns on again after the junction temperature cools by 25°C .

For continue operation, do not exceed absolute maximum operation junction temperature 125°C . The power dissipation definition in device is:

$$P_{\text{D(MAX)}} = (T_{\text{J(MAX)}} - T_{\text{A}}) / \theta_{\text{JA}}$$

Where $T_{\text{J(MAX)}}$ is the maximum operation junction temperature 125°C , T_{A} is the ambient temperature and the θ_{JA} is the junction to ambient thermal resistance. For recommended operating conditions specification of A6500B, where $T_{\text{J(MAX)}}$ is the maximum junction temperature of the die (125°C) and T_{A} is the maximum ambient temperature. The junction to ambient thermal resistance (θ_{JA} is layout dependent) for SOT-25



package is 250°C/W, on standard JEDEC 51-3 thermal test board. The maximum power dissipation at $T_A = 25^\circ\text{C}$ can be calculated by following formula:

$$P_{D(\text{MAX})} = (125^\circ\text{C} - 25^\circ\text{C}) / 250 = 400\text{mW (SOT-25)}$$

Layout considerations

To improve ac performance such as PSRR, output noise, and transient response, it is recommended that the PCB be designed with separate ground planes for V_{IN} and V_{OUT} , with each ground plane connected only at the GND pin of the device.



PACKAGE INFORMATION

Dimension in SOT-25 (Unit: mm)

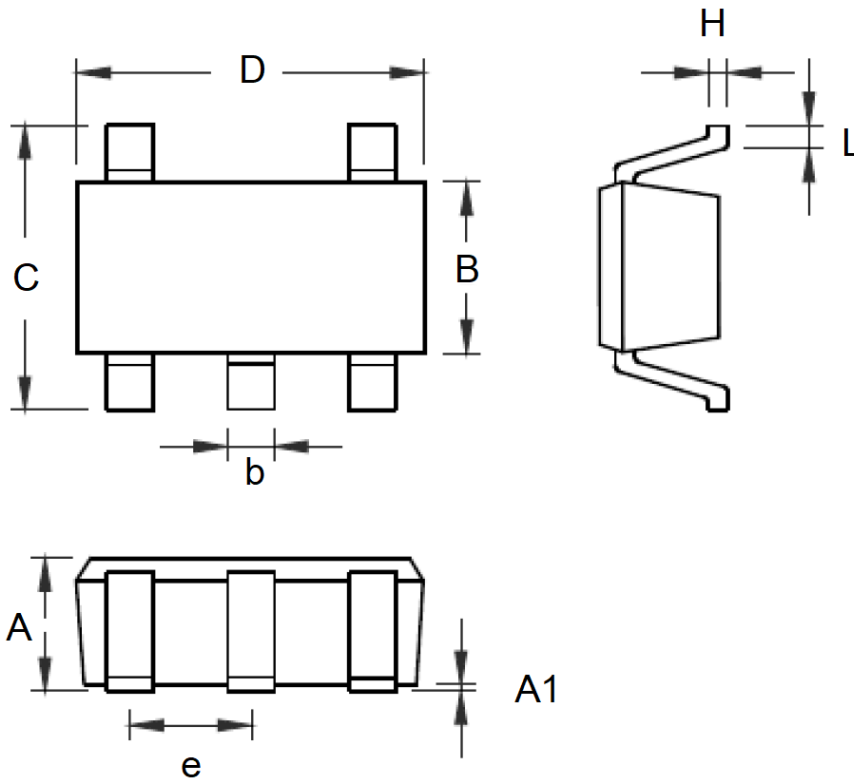

Symbol	Millimeters		Inches	
	Min	Max	Min	Max
A	0.889	1.295	0.035	0.051
A1	0.000	0.152	0.000	0.006
B	1.397	1.803	0.055	0.071
b	0.356	0.559	0.014	0.022
C	2.591	2.997	0.102	0.118
D	2.692	3.099	0.106	0.122
e	0.838	1.041	0.033	0.041
H	0.080	0.254	0.003	0.010
L	0.300	0.610	0.012	0.024



Dimension in DFN4(1x1) (Unit: mm)

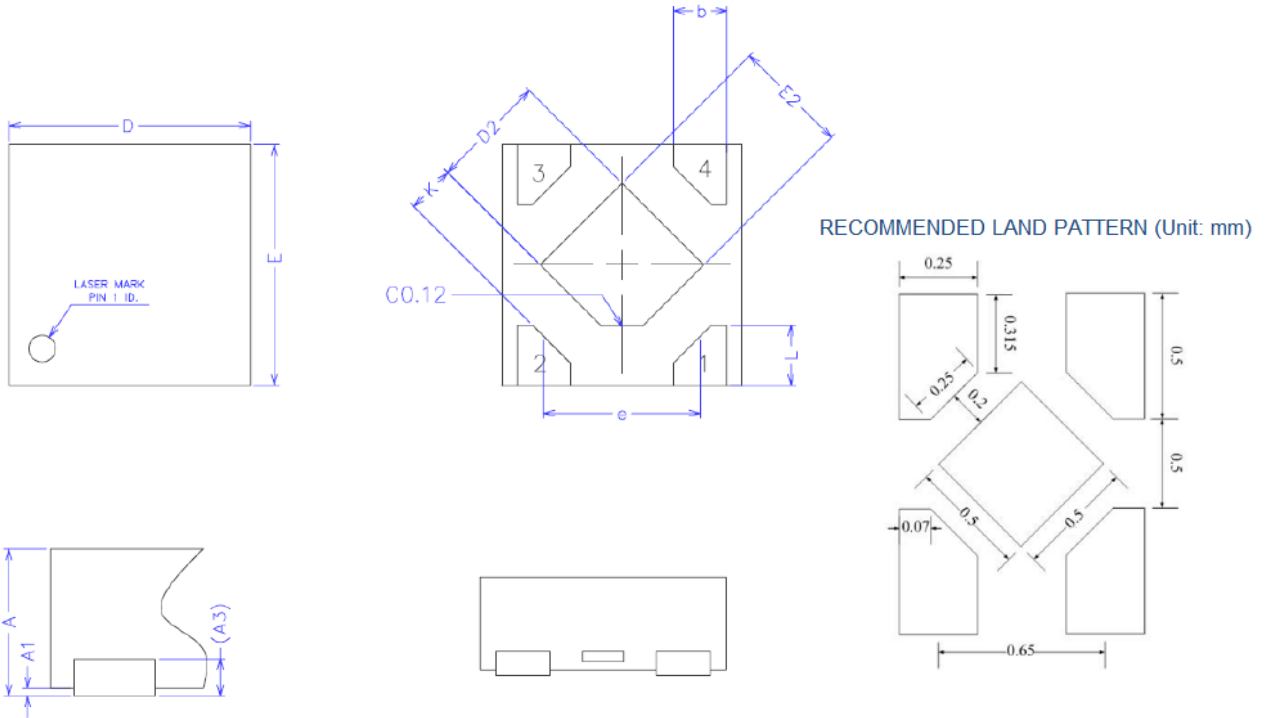

Symbol	Min	Max
A	0.34	0.40
A1	0.00	0.05
A3	0.100 REF	
b	0.17	0.27
D	0.95	1.05
E	0.95	1.05
D2	0.43	0.53
E2	0.43	0.53
L	0.20	0.30
e	0.65	
K	0.15	-



IMPORTANT NOTICE

AiT Semiconductor Inc. (AiT) reserves the right to make changes to any its product, specifications, to discontinue any integrated circuit product or service without notice, and advises its customers to obtain the latest version of relevant information to verify, before placing orders, that the information being relied on is current.

AiT Semiconductor Inc.'s integrated circuit products are not designed, intended, authorized, or warranted to be suitable for use in life support applications, devices or systems or other critical applications. Use of AiT products in such applications is understood to be fully at the risk of the customer. As used herein may involve potential risks of death, personal injury, or severe property, or environmental damage. In order to minimize risks associated with the customer's applications, the customer should provide adequate design and operating safeguards.

AiT Semiconductor Inc. assumes to no liability to customer product design or application support. AiT warrants the performance of its products of the specifications applicable at the time of sale.