



DESCRIPTION

A1084 is a series of low dropout three terminal regulators with a typical dropout voltage of 1.4V at 5A load current.

Other than fixed voltage versions (1.8V, 2.5V, 3.3V, 5.0V), A1084 has an adjustable voltage version, with which desired voltage can be achieved by setting the values of two external resistors of the application circuitry.

A1084 offers thermal shut down and current limit functions to assure the stability of chip and power system.

The A1084 is available in TO-252, TO-263-2 and TO-263-3 packages.

ORDERING INFORMATION

Package Type	Part Number	
TO-252 SPQ: 2,500pcs/Reel	D	A1084DR-XX
		A1084DVR-XX
TO-263-2 SPQ: 800pcs/Reel	S2	A1084S2R-XX
		A1084S2VR-XX
TO-263-3 SPQ: 800pcs/Reel	S3	A1084S3R-XX
		A1084S3VR-XX
Note	XX: Output Voltage, 18 = 1.8V, 33 = 3.3V, ADJ: Adjustable V: Halogen free Package R: Tape & Reel	
AiT provides all RoHS products		

FEATURES

- Fixed and adjustable versions.
- Maximum output current : 5A
- Maximum input voltage: 15V
- Line regulation: 0.2% (Typical)
- Load regulation: 0.2% (Typical)
- On-Chip Thermal Shutdown
- Operation environment Temperature: -40°C~ 85°C
- Available in TO-252, TO-263-2 and TO-263-3 packages

APPLICATION

- Power Management for Computer Mother Board, Graphic Card
- Battery Charger
- Post Regulators for Switching Supplies
- Microprocessor Supply

TYPICAL APPLICATION

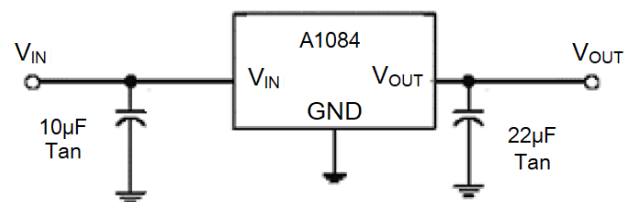
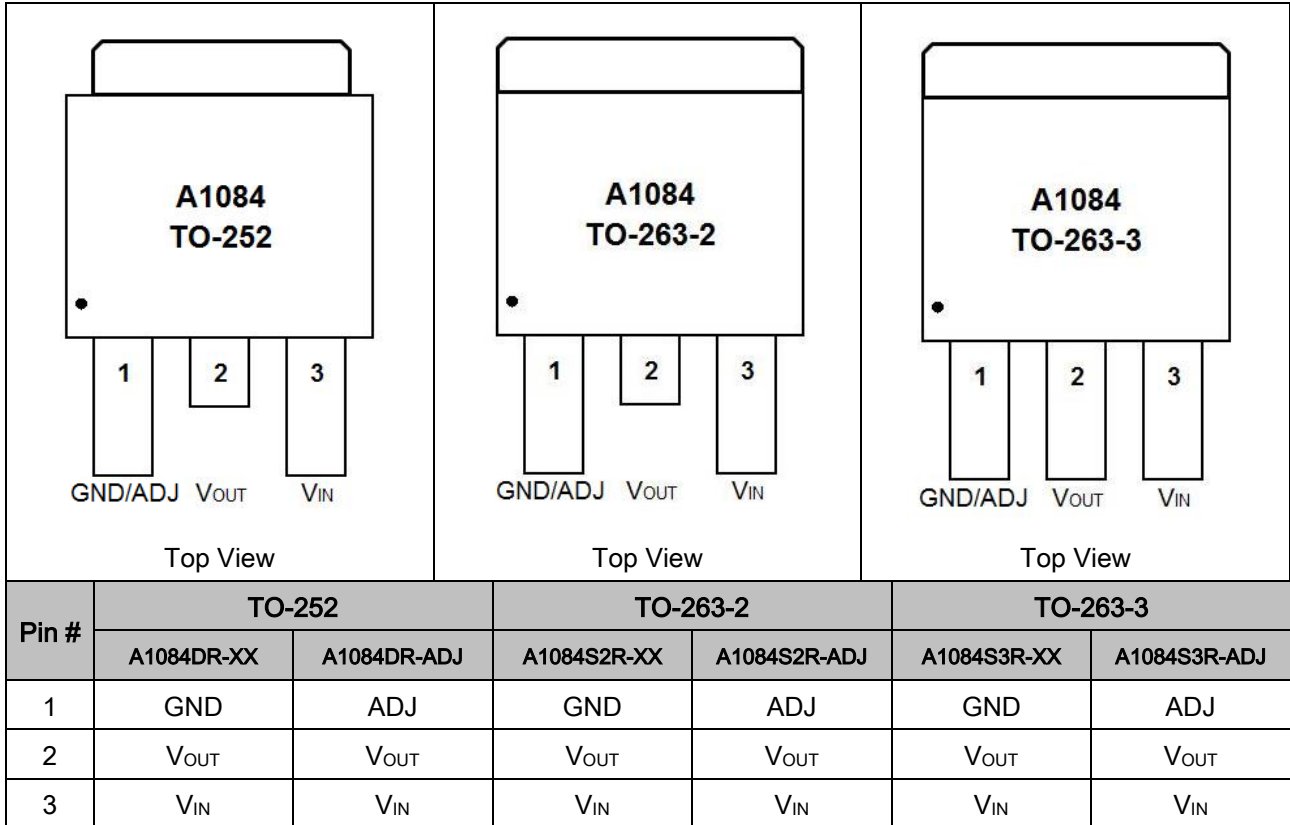

Fig 1. A1084 fixed version application circuit

NOTE: Input capacitor ($C_{IN}=10\mu F$) and Output capacitor ($C_{OUT}=22\mu F$) are recommended in all application circuit. Tantalum capacitor is preferred.



PIN DESCRIPTION





ABSOLUTE MAXIMUM RATINGS

Max Input Voltage		15V
T _J , Operating Junction Temperature		150°C
T _A , Ambient Temperature		-40°C ~85°C
Package Thermal Resistance	TO-252	6°C/W
	TO-263	3°C/W
T _S , Storage Temperature		-40°C ~150°C
Lead Temperature & Time		260°C, 10s

Stress beyond above listed "Absolute Maximum Ratings" may lead permanent damage to the device. These are stress ratings only and operations of the device at these or any other conditions beyond those indicated in the operational sections of the specifications are not implied. Exposure to absolute maximum rating conditions for extended periods may affect device reliability.

RECOMMENDED WORK CONDITIONS

Parameter	Symbol	Conditions	Min.	Typ.	Max.	Unit
Input Voltage Range			-	-	15	V
Operating Junction Temperature	T _J		-20	-	125	°C



ELECTRICAL CHARACTERISTICS

T_J = 25°C

Parameter	Symbol	Conditions	Min.	Typ.	Max.	Unit
Reference Voltage	V _{REF}	10mA ≤ I _{OUT} ≤ 5A, 1.5V ≤ V _{IN} - V _{OUT} ≤ 5V	1.225	1.25	1.275	V
Output Voltage	V _{OUT}	1.8V I _{OUT} = 0mA, V _{IN} = 4.8V, T _J = 25°C 10mA ≤ I _{OUT} ≤ 5A, 3.4V ≤ V _{IN} ≤ 7V	1.773 1.764	1.80 1.80	1.827 1.836	V
		2.5V I _{OUT} = 0mA, V _{IN} = 5.5V, T _J = 25°C 10mA ≤ I _{OUT} ≤ 5A, 4.1V ≤ V _{IN} ≤ 7V	2.462 2.45	2.50 2.50	2.537 2.55	V
		3.3V I _{OUT} = 0mA, V _{IN} = 6.3V, T _J = 25°C 10mA ≤ I _{OUT} ≤ 5A, 4.9V ≤ V _{IN} ≤ 8V	3.25 3.234	3.3 3.3	3.350 3.366	V
		5.0V I _{OUT} = 0mA, V _{IN} = 8.0V, T _J = 25°C 10mA ≤ I _{OUT} ≤ 5A, 6.6V ≤ V _{IN} ≤ 10V	4.925 4.90	5.0 5.0	5.075 5.10	V
Line Regulation NOTE1	ΔV _{OUT}	ADJ I _{OUT} = 10mA, 2.85V ≤ V _{IN} ≤ 10V	-	10	40	mV
		1.8V I _{OUT} = 10mA, 3.4V ≤ V _{IN} ≤ 10V	-	10	40	mV
		2.5V I _{OUT} = 10mA, 4.1V ≤ V _{IN} ≤ 10V	-	10	40	mV
		3.3V I _{OUT} = 10mA, 4.9V ≤ V _{IN} ≤ 10V	-	10	40	mV
		5.0V I _{OUT} = 10mA, 6.6V ≤ V _{IN} ≤ 10V	-	10	40	mV
Load Regulation NOTE1, 2	ΔV _{OUT}	ADJ ADJ connected to ground V _{IN} - V _{OUT} = 1.6V, 10mA ≤ I _{OUT} ≤ 5A	-	16	50	mV
		1.8V V _{IN} - V _{OUT} = 1.6V, 0mA ≤ I _{OUT} ≤ 5A	-	16	50	mV
		2.5V V _{IN} - V _{OUT} = 1.6V, 0mA ≤ I _{OUT} ≤ 5A	-	16	50	mV
		3.3V V _{IN} - V _{OUT} = 1.6V, 0mA ≤ I _{OUT} ≤ 5A	-	16	50	mV
		5.0V V _{IN} - V _{OUT} = 1.6V, 0mA ≤ I _{OUT} ≤ 5A	-	16	50	mV
Dropout Voltage NOTE3	V _{IN} - V _{OUT}	ΔV _{OUT} , ΔV _{REF} = 1%, I _{OUT} = 5A	-	1.4	1.6	V



Parameter	Symbol	Conditions	Min.	Typ.	Max.	Unit
Current Limit	I _{LIMIT}	V _{IN} - V _{OUT} = 3V, T _J = 25°C	-	7	-	A
Minimum Load Current ^{NOTE4}		A1084-ADJ	-	3	10	mA
Quiescent Current	I _q	V _{IN} = 10V	-	5	10	mA
Adjust Pin Current	I _{ADJ}	Adjustable Version 2.85V ≤ V _{IN} ≤ 4.25V, 10mA ≤ I _{OUT} ≤ 5A	-	45	120	μA
Ripple Rejection		f = 120Hz, C _{OUT} = 25μF (Tan) I _{OUT} = 5A, V _{IN} - V _{OUT} = 3V	60	65	-	dB
Adjust Pin Current Change	I _{CHANGE}	10mA ≤ I _{OUT} ≤ 5A, 1.5V ≤ V _{IN} - V _{OUT} ≤ 6V	-	0.4	10	μA
Temperature Stability		I _{OUT} = 10mA, V _{IN} - V _{OUT} = 1.5V	-	-	0.5	%
Thermal Resistance junction to Case	θ _{JC}	TO-252 TO-263	-	12.5 3	-	°C/W
Over Temperature Protection	OTP		-	150	-	°C

NOTE1: Line Regulation and Load Regulation are tested under constant junction temperature.

NOTE2: When load current varies between 0~5A and V_{IN}-V_{OUT} ranges from 1.5V~6V at constant junction temperature, the parameter is satisfied the criterion in table. If temperature varies between -40°C ≤ T_A ≤ 85°C, it needs output current to be larger than 10mA to satisfy the criterion.

NOTE3: Dropout Voltage is the voltage difference between the input and output pin when the input voltage is minimum to maintain the lowest spec output voltage.

Dropout Voltage is the voltage difference between the input and output pin under I_{OUT}=5A and the following test condition:

- 1) Find out output voltage value (as V_{OUT1}) when V_{IN1}=V_{OUT1}+1.5V
- 2) Decrease input voltage until output voltage is equal to 98.5% of V_{OUT1}, and the V_{IN} and V_{OUT} as V_{IN2} and V_{OUT2}.
- 3) V_{DROPOUT}=V_{IN2}-V_{OUT2}.

NOTE4: Minimum Load Current is defined as the minimum output current necessary to maintain regulation. Specified output accuracy can be met when the output current exceeds the minimum load current (10mA) and the dropout voltage (V_{IN}-V_{OUT}) between 1.5V and 6V.



TYPICAL PERFORMANCE CHARACTERISTICS

1. Dropout Voltage vs. Output Current

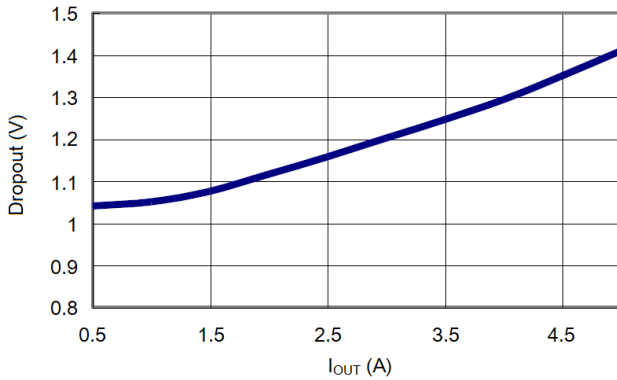

2. Output Voltage vs. Temperature

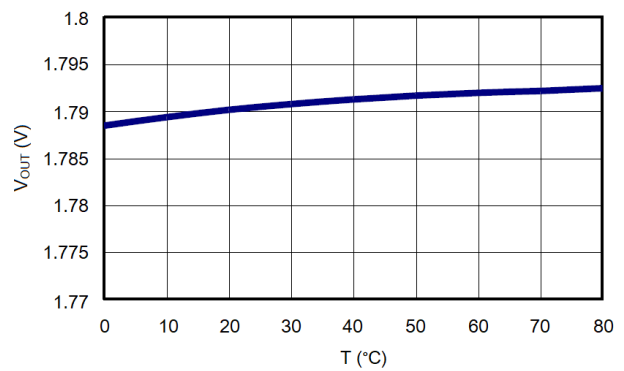

3. Output Voltage vs. Output Current

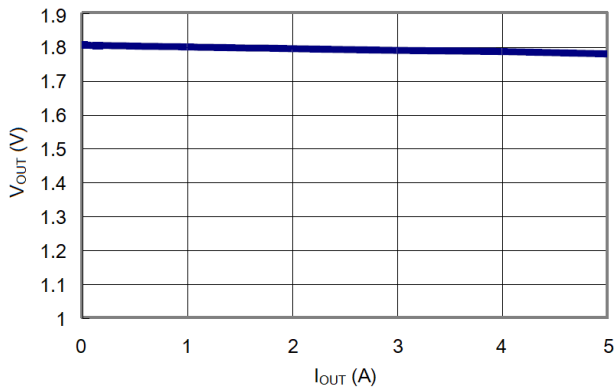

4. Load Transient Response

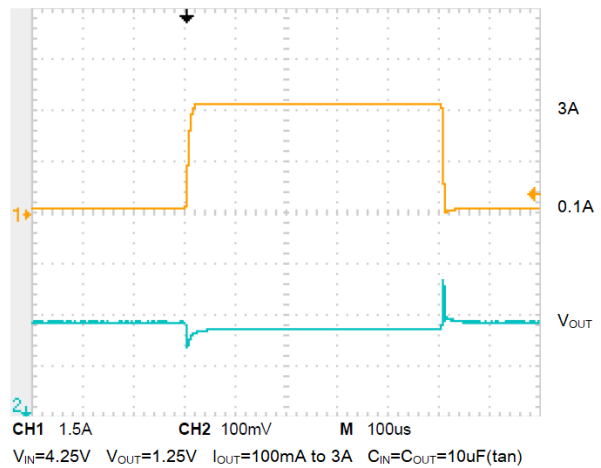

5. Line Transient Response

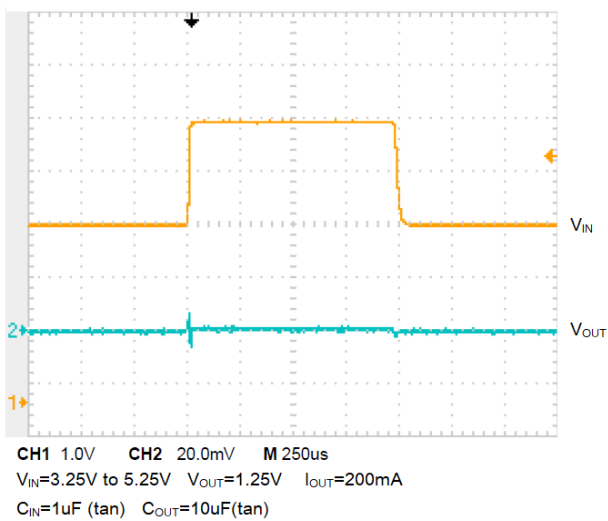



BLOCK DIAGRAM

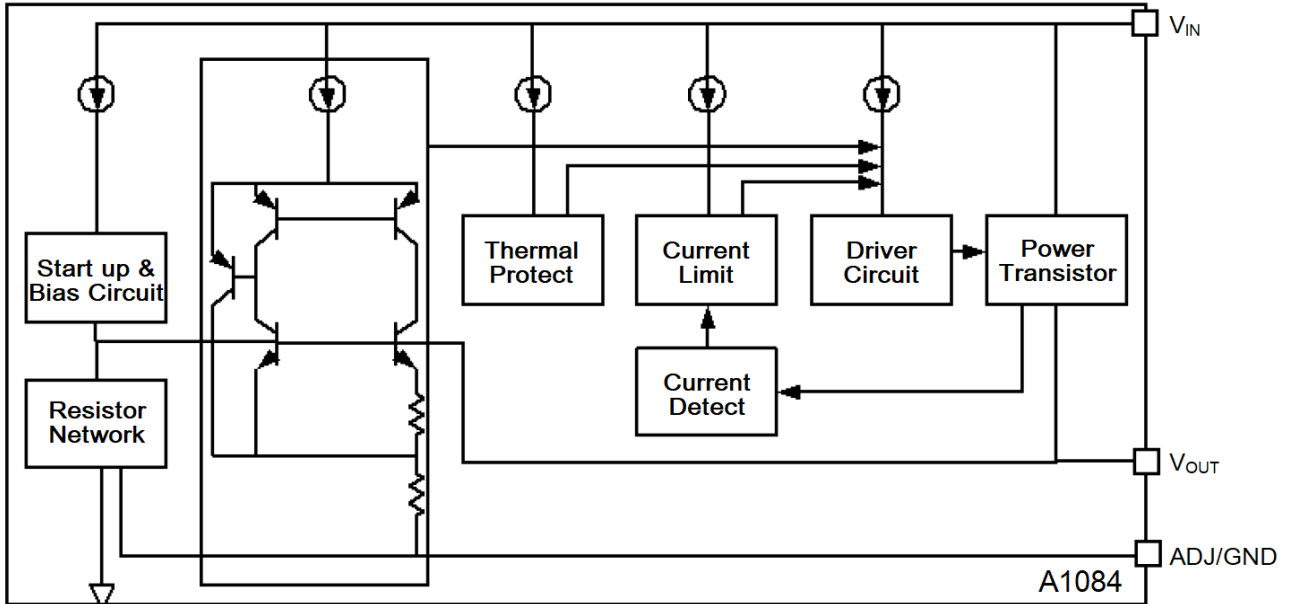



DETAILED INFORMATION

A1084 is a series of low dropout voltage three terminal regulators. Its circuit has a trimmed bandgap reference to ensure output voltage accuracy independent of temperature variance. On-chip thermal shutdown provides protection against overload and conditions as elevated ambient temperature.

Its application circuitry requires minimum number of external components. Both fixed voltage and adjustable voltage versions need input and output capacitors to assure output voltage stability. Any desired output voltage from 1.25V to 10V can be achieved with adjustable version by assigning proper values to two external resistors in its application circuitry (as shown in Fig.1, as R1, R2 are the two external resistors.).

Typical Application

A1084 has an adjustable version and fixed versions, Fig.1 shows their typical application circuitry.

A 10uF tan capacitor connected between input and GND as bypass capacitor and a 22uF tan capacitor between output and GND are recommended for all application.

Using a bypass capacitor (C_{ADJ}) between the adjust terminal and ground can improve ripple rejection. The bypass capacitor prevents ripple from being amplified in case the output voltage is increased. The impedance of C_{ADJ} should be less than the resistance of R1 to prevent ripple from being amplified at any frequency. As R1 is normally in the range of 120Ω~200Ω, the value of C_{ADJ} should satisfy the following condition:

$$1 / (2\pi \times \text{Frequency}_{\text{Ripple}} \times C_{ADJ}) < R1$$

A 10μF tan capacitor is recommended.

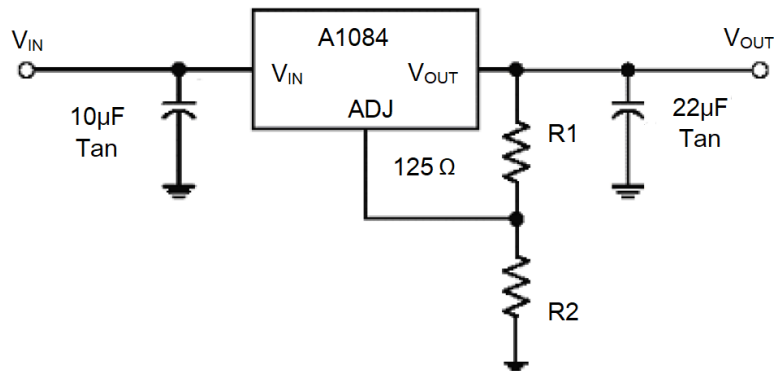

$$V_{OUT} = V_{REF} \times (1 + R_2/R_1) + I_{ADJ} \times R_2$$

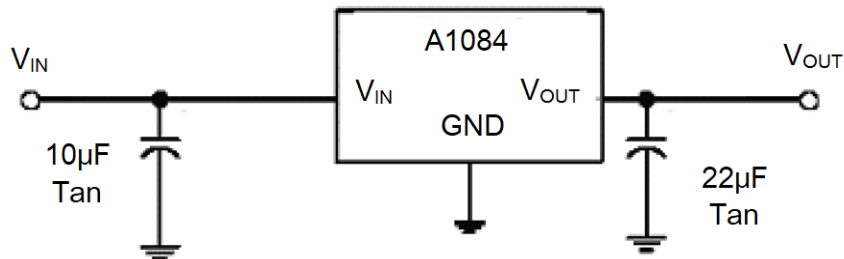

Fig 1. Typical Application of A1084

Explanation

The output voltage of adjustable version satisfies this followed equation:

$$V_{OUT} = V_{REF} \times (1 + R_2 / R_1) + I_{ADJ} \times R_2.$$

The second term $I_{ADJ} \times R_2$ can be ignored since the adjustable pin current I_{ADJ} (~ 50µA) is much less than the current through R_1 (~ 4mA).

The value of R_1 is preferred in the range of 120Ω ~ 200Ω and the total output current of the adjustable version of A1084 needs to exceed 10mA to assure normal chip operation.



PACKAGE INFORMATION

Dimension in TO-252 (Unit: mm)

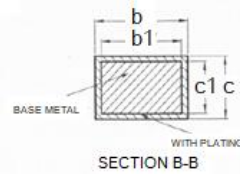
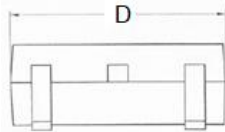
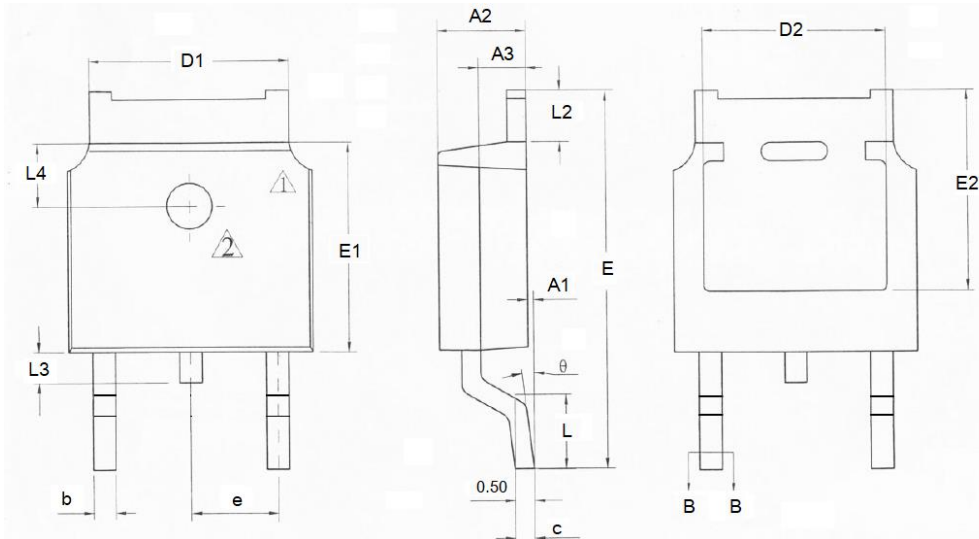

Symbol	Min	Max
A1	0	0.10
A2	2.20	2.40
A3	1.02	1.12
b	0.75	0.84
b1	0.74	0.79
c	0.49	0.57
c1	0.48	0.52
D	6.50	6.70
D1	5.334 REF	
D2	4.70	4.92
E	9.90	10.30
E1	6.00	6.20
E2	5.30 REF	
e	2.286 BSC	
L	1.40	1.60
L2	0.90	1.25
L3	0.60	1.00
L4	1.70	1.90
θ	0°	8°



Dimension in TO-263-2 (Unit: mm)

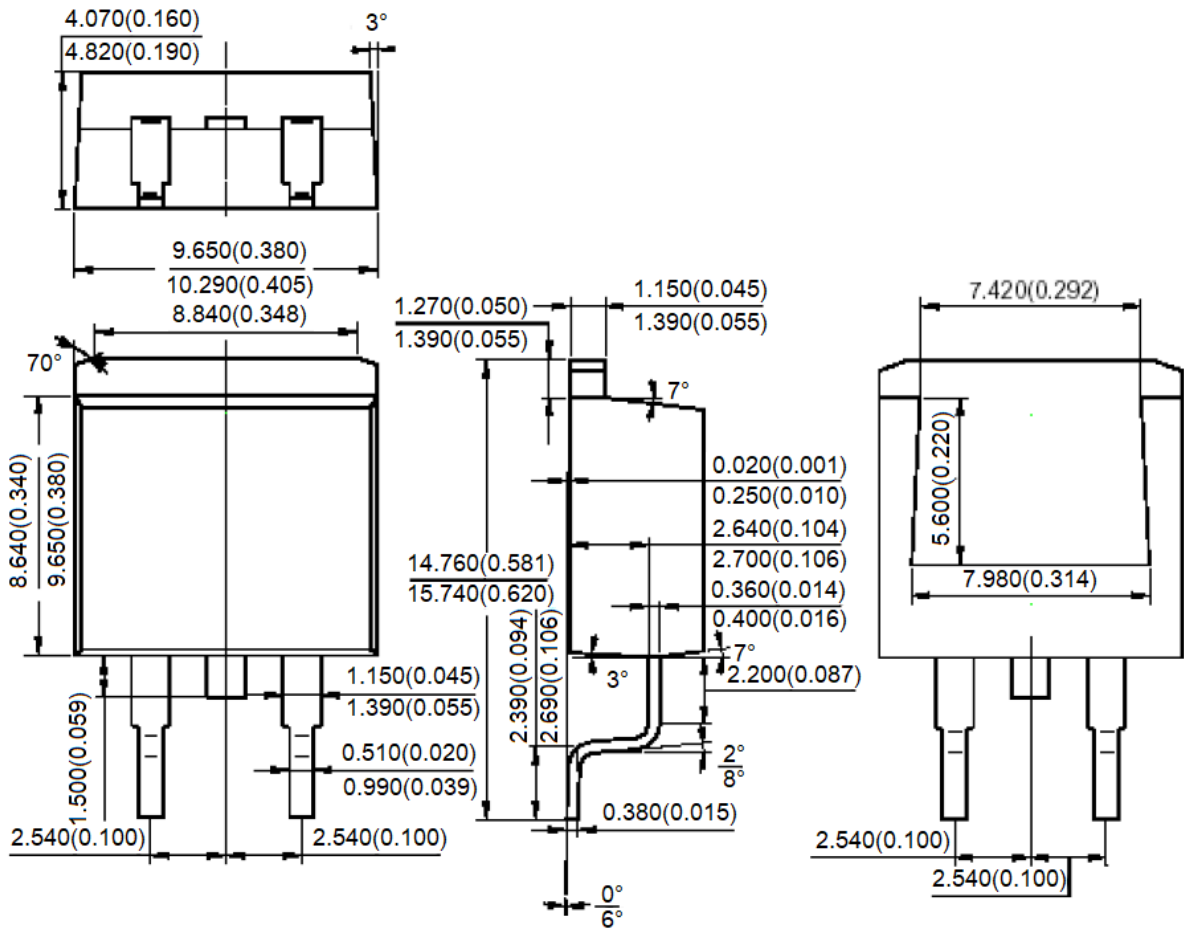



Dimension in TO-263-3 (Unit: mm)

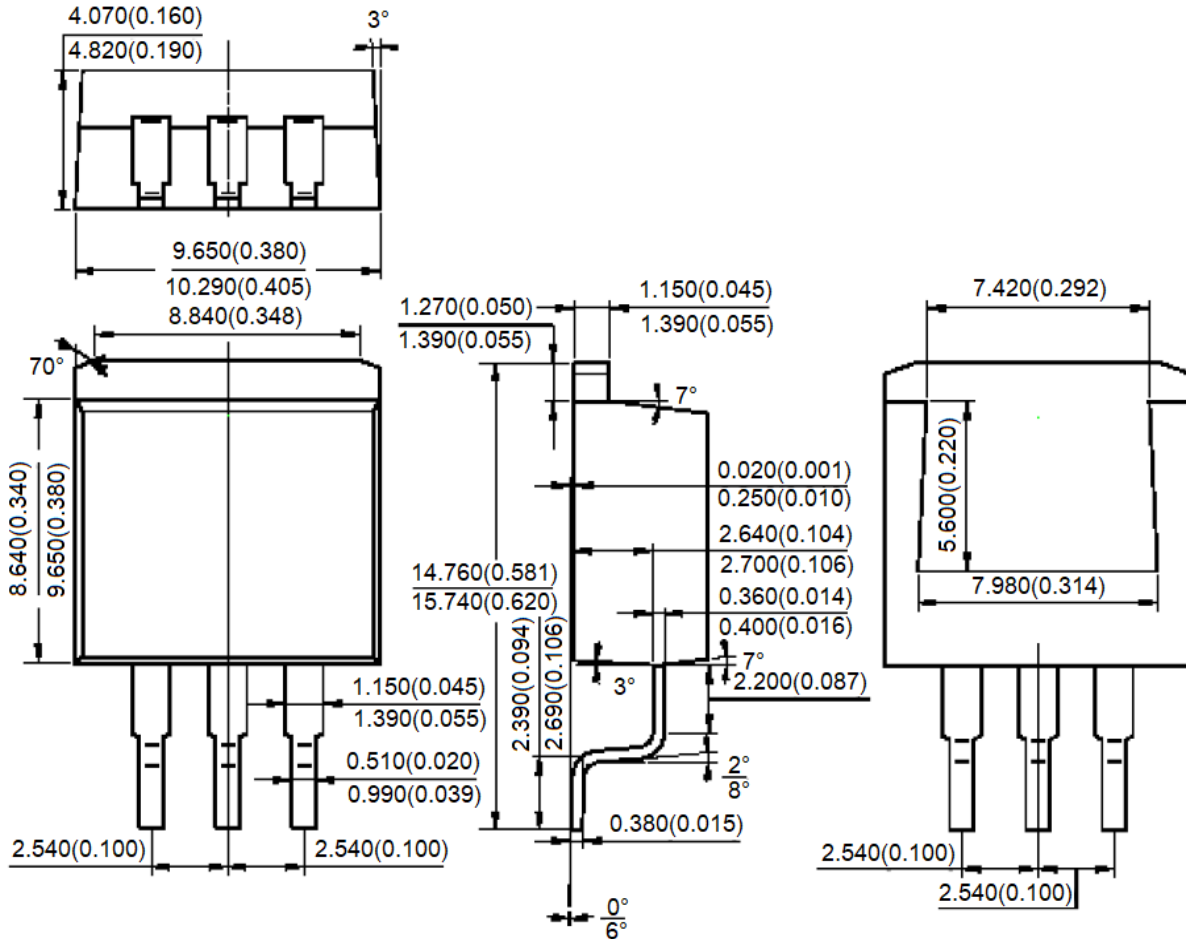



IMPORTANT NOTICE

AiT Semiconductor Inc. (AiT) reserves the right to make changes to any its product, specifications, to discontinue any integrated circuit product or service without notice, and advises its customers to obtain the latest version of relevant information to verify, before placing orders, that the information being relied on is current.

AiT Semiconductor Inc.'s integrated circuit products are not designed, intended, authorized, or warranted to be suitable for use in life support applications, devices or systems or other critical applications. Use of AiT products in such applications is understood to be fully at the risk of the customer. As used herein may involve potential risks of death, personal injury, or severe property, or environmental damage. In order to minimize risks associated with the customer's applications, the customer should provide adequate design and operating safeguards.

AiT Semiconductor Inc. assumes to no liability to customer product design or application support. AiT warrants the performance of its products of the specifications applicable at the time of sale.