



DESCRIPTION

The 1SS184 is available in SOT-23 package.

FEATURES

- Low forward voltage : $V_F(3) = 0.9V$ (typ.)
- Fast reverse recovery time : $t_{RR} = 1.6ns$ (typ.)
- Small total capacitance : $C_T = 0.9pF$ (typ.)
- RoHS Compliant
- Available in SOT-23 package

ORDERING INFORMATION

Package Type	Part Number
SOT-23	1SS184
Note	3,000Tape/Reel
AiT provides all RoHS Compliant Products	

PIN DESCRIPTION

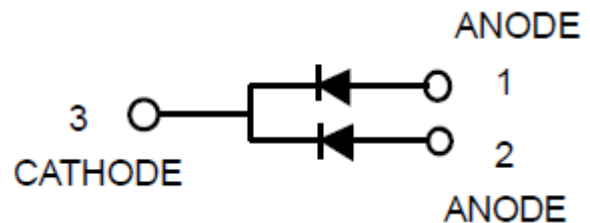

ABSOLUTE MAXIMUM RATINGS

$T_A = 25^\circ C$

V_{RM} , Maximum (peak) reverse voltage	85 V
V_R , Reverse voltage	80 V
I_{FM} , Maximum (peak) forward current	300mA ^{Note1}
I_o , Average forward current	100mA ^{Note1}
I_{FSM} , Surge current (10ms)	2A ^{Note1}
P_D , Power dissipation	150mW
T_J , Junction temperature	125 °C
T_{STG} , Storage temperature range	-55°C ~+125 °C

Stresses above may cause permanent damage to the device. These are stress ratings only and functional operation of the device at these or any other conditions beyond those indicated in the Electrical Characteristics are not implied. Exposure to absolute maximum rating conditions for extended periods may affect device reliability.

NOTE1: Unit rating. Total rating = Unit rating \times 0.7



ELECTRICAL CHARACTERISTICS

$T_A = 25^\circ\text{C}$

Parameter	Symbol	Conditions	Min	Typ.	Max	Unit
Forward voltage	$V_{F(1)}$	$I_F = 1\text{mA}$	-	0.60	-	V
	$V_{F(2)}$	$I_F = 10\text{mA}$	-	0.72	-	
	$V_{F(3)}$	$I_F = 100\text{mA}$	-	0.90	1.20	
Reverse current	$I_{R(1)}$	$V_R = 30\text{V}$	-	-	0.1	μA
	$I_{R(2)}$	$V_R = 80\text{V}$	-	-	0.5	
Total capacitance	C_T	$V_R = 0, f = 1\text{MHz}$	-	0.9	3.0	pF
Reverse recovery time	t_{RR}	$I_F = 10\text{mA}$ (Figure 1)	-	1.6	4.0	ns



TYPICAL CHARACTERISTICS

Figure 1. Forward Voltage $V_F(V)$

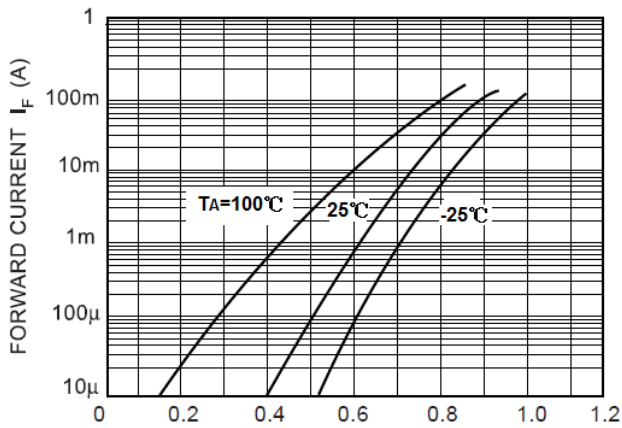

Figure 2. Reverse Voltage $V_R(V)$

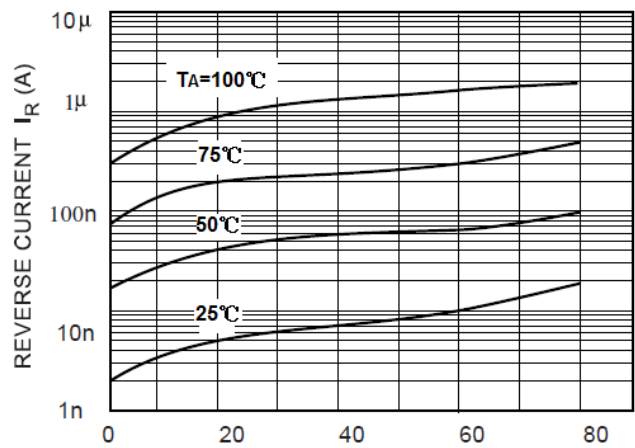

Figure 3. Reverse Voltage $V_R(V)$

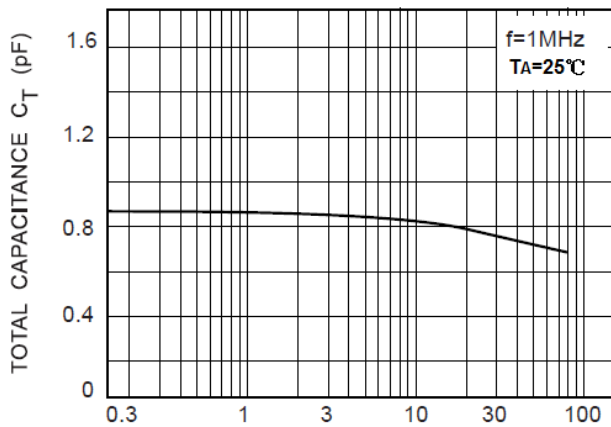

Figure 4. Forward Current $I_F(\text{mA})$

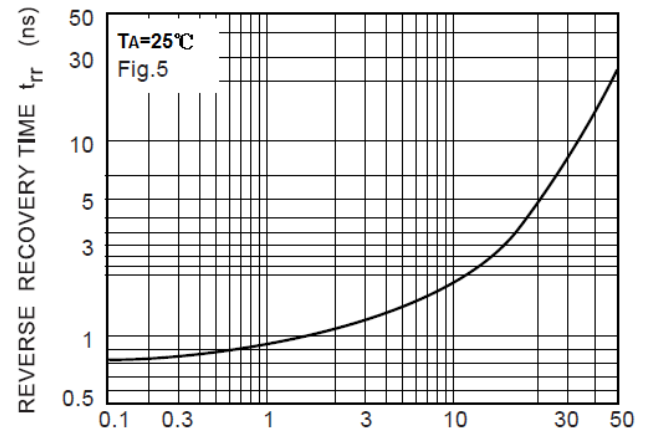
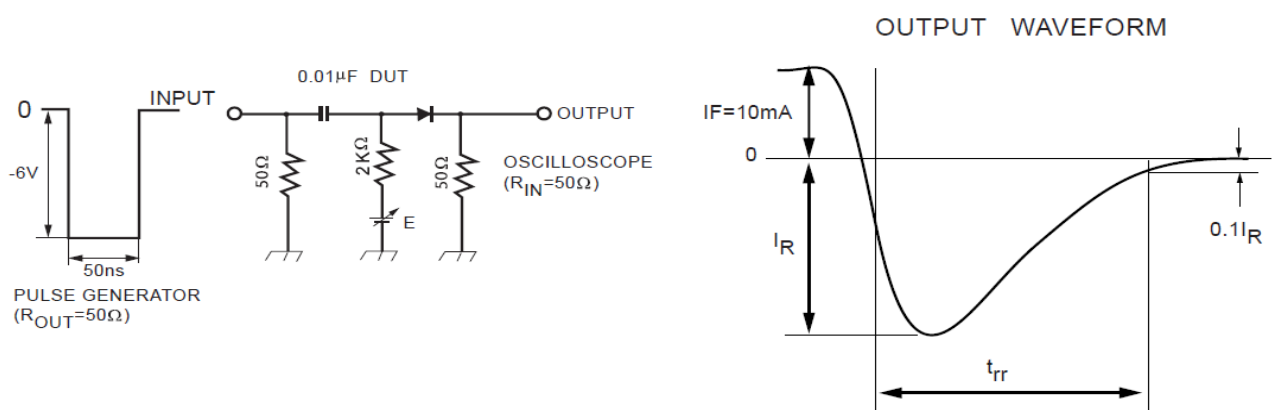

Figure 5. Reverse recovery time (t_{RR}) test circuit





PACKAGE INFORMATION

Dimension in SOT-23 Package (Unit: mm)

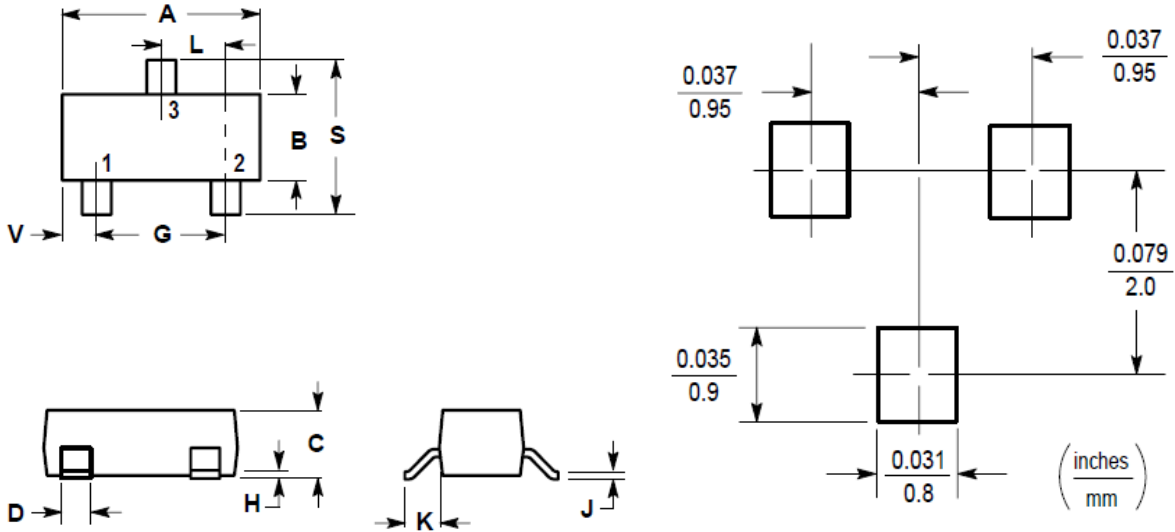

DIM	MILLIMETERS		INCHES	
	MIN	MAX	MIN	MAX
A	2.80	3.04	0.1102	0.1197
B	1.20	1.40	0.0472	0.0551
C	0.89	1.11	0.0350	0.0440
D	0.37	0.50	0.0150	0.0200
G	1.78	2.04	0.0701	0.0807
H	0.013	0.100	0.0005	0.0040
J	0.085	0.177	0.0034	0.0070
K	0.35	0.69	0.0140	0.0285
L	0.89	1.02	0.0350	0.0401
S	2.10	2.64	0.0830	0.1039
V	0.45	0.60	0.0177	0.0236



IMPORTANT NOTICE

AiT Semiconductor Inc. (AiT) reserves the right to make changes to any its product, specifications, to discontinue any integrated circuit product or service without notice, and advises its customers to obtain the latest version of relevant information to verify, before placing orders, that the information being relied on is current.

AiT Semiconductor Inc.'s integrated circuit products are not designed, intended, authorized, or warranted to be suitable for use in life support applications, devices or systems or other critical applications. Use of AiT products in such applications is understood to be fully at the risk of the customer. As used herein may involve potential risks of death, personal injury, or severe property, or environmental damage. In order to minimize risks associated with the customer's applications, the customer should provide adequate design and operating safeguards.

AiT Semiconductor Inc. assumes to no liability to customer product design or application support. AiT warrants the performance of its products of the specifications applicable at the time of sale.